

1. Most details included herein are drawn to full scale.
2. Details shown herein, illustrate 1 1/2" composite panels. Other thicknesses are available. Refer to other sections of this literature for additional options or consult Protean for any special requirements.
3. In general, panel attachment should be made along the long edge of the panels.
4. Details as shown herein illustrate a horizontal installation with subgirts and panel attachment located at the horizontal joints. For a vertical panel installation, modify details to install panels vertically.
5. Alternate subgirt layouts are available where subgirts can be oriented in the opposite direction of the long edge of the panels. Contact Protean for further information on these types of installations.
6. The enclosed details represent typical standard details for the ACM-2000RS system. In so much as the ACM-2000RS is a custom designed system, this is only the beginning of the possibilities. Consult Protean for assistance in developing custom details for your application.

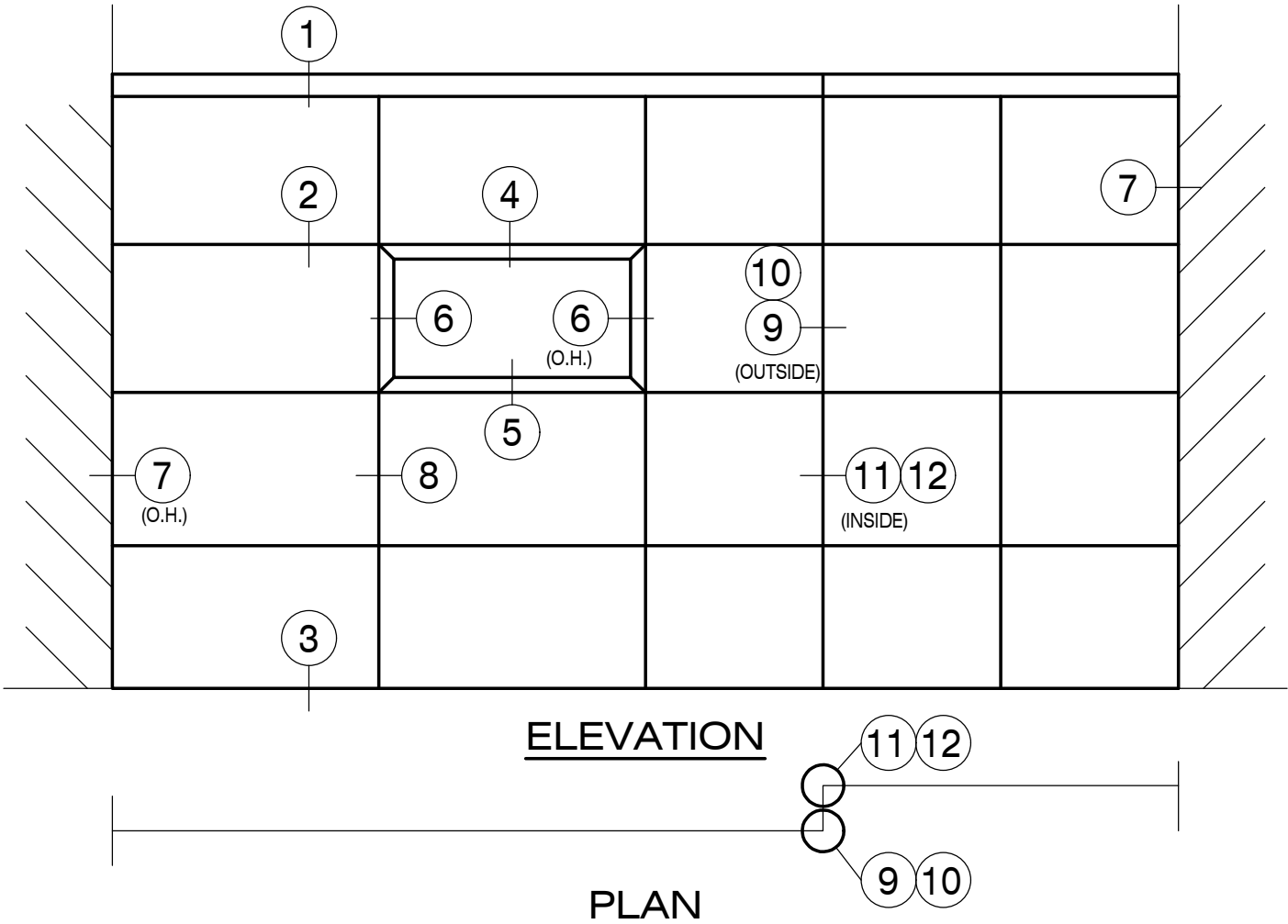

INDEX

<u>SHEET #</u>	<u>DESCRIPTION</u>	<u>SHEET #</u>	<u>DESCRIPTION</u>
ACM-2000RS / 1	PARAPET CAP	ACM-2000RS / 8	VERTICAL JOINT
ACM-2000RS / 2	HORIZONTAL JOINT	ACM-2000RS / 9	OUTSIDE CORNER (BENT)
ACM-2000RS / 3	BASE DETAIL	ACM-2000RS / 10	OUTSIDE CORNER (MITERED)
ACM-2000RS / 4	WINDOW HEAD	ACM-2000RS / 11	INSIDE CORNER (BENT)
ACM-2000RS / 5	WINDOW SILL	ACM-2000RS / 12	INSIDE CORNER (MITERED)
ACM-2000RS / 6	WINDOW JAMB		
ACM-2000RS / 7	JAMB DETAIL		

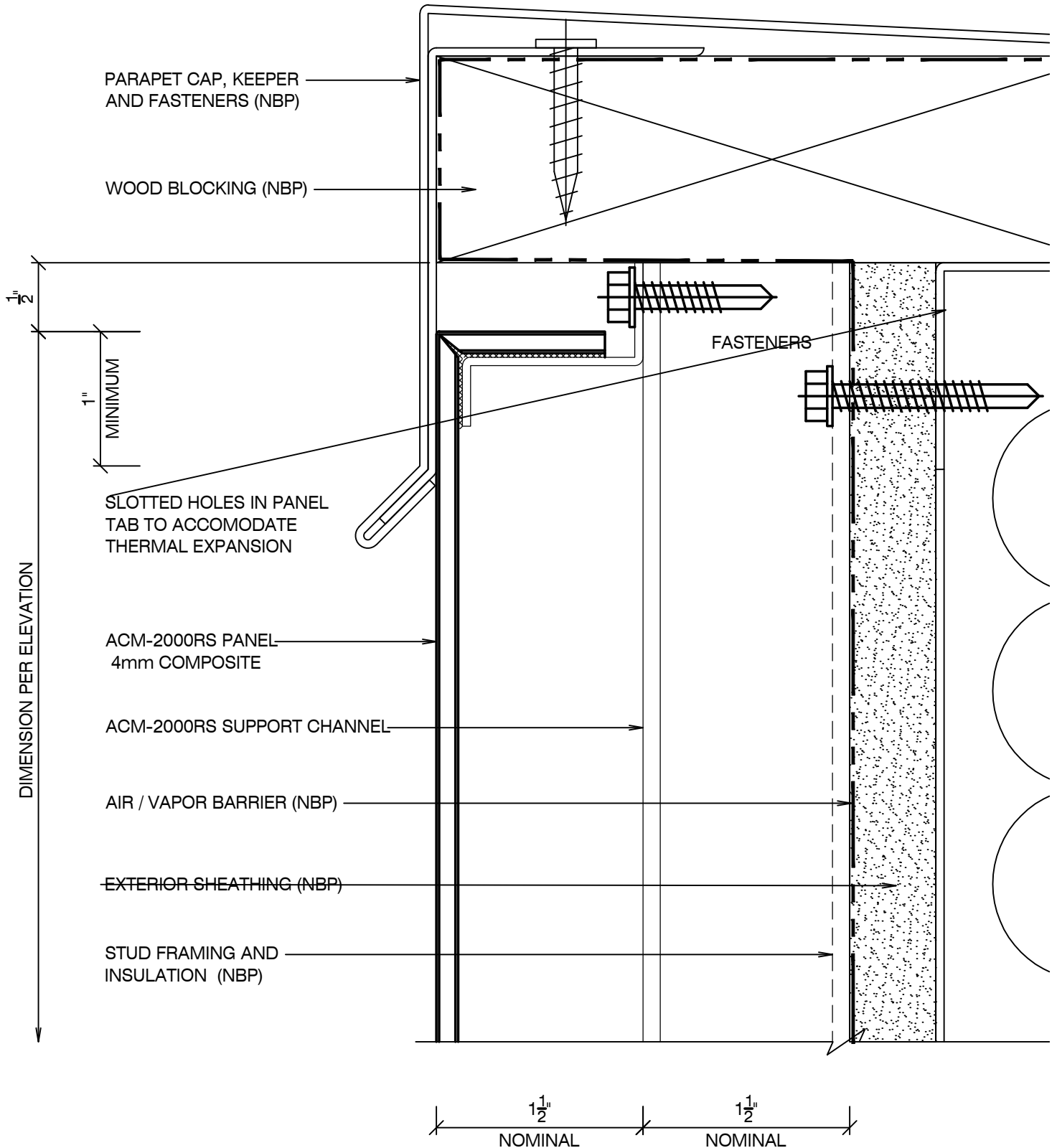

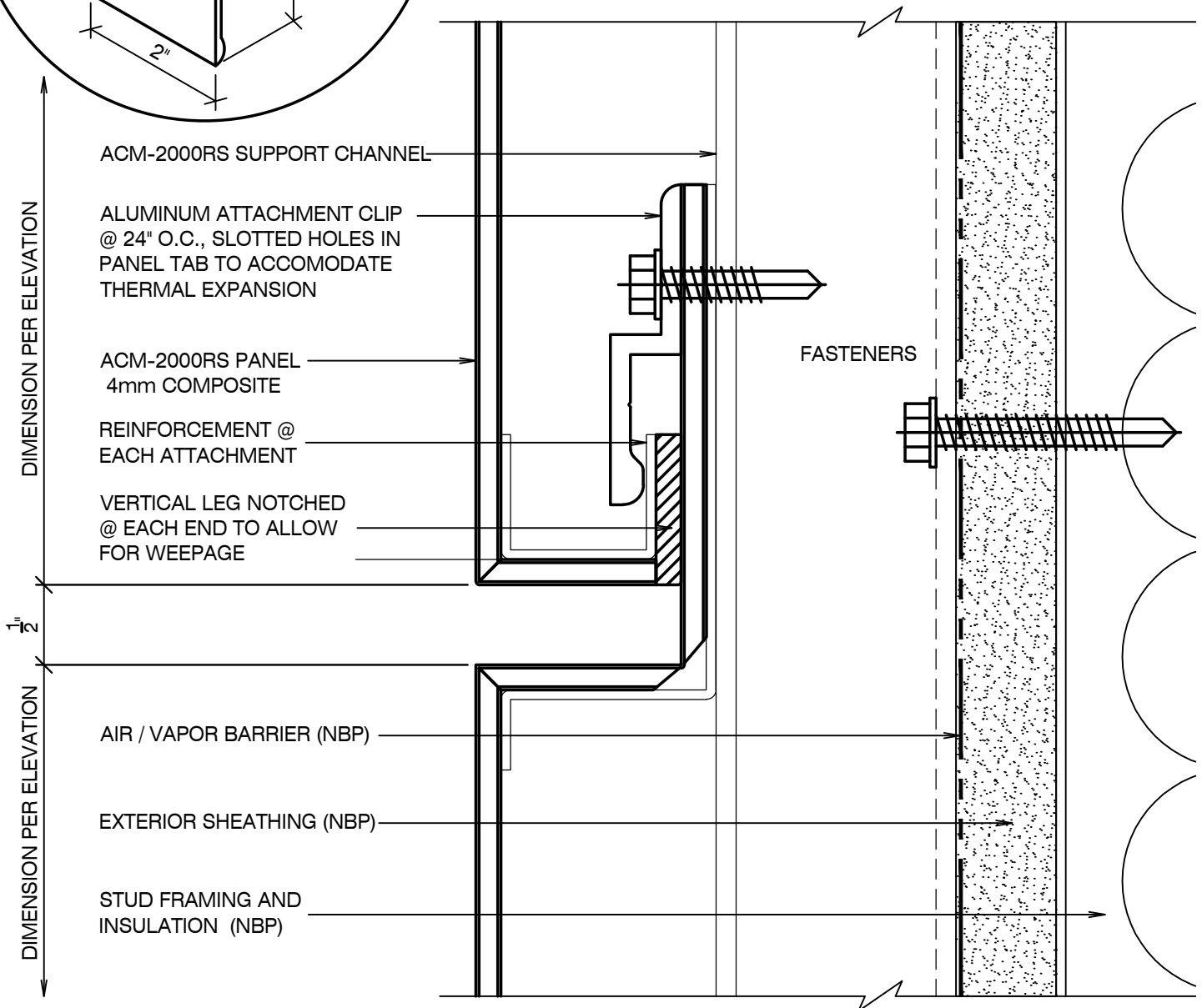
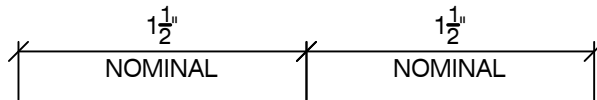
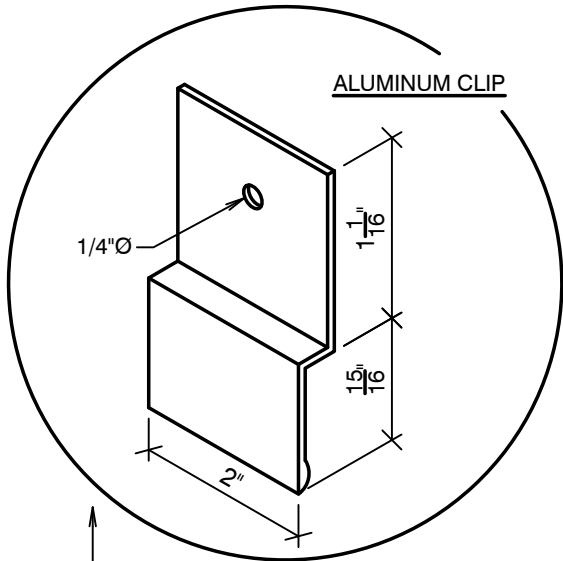

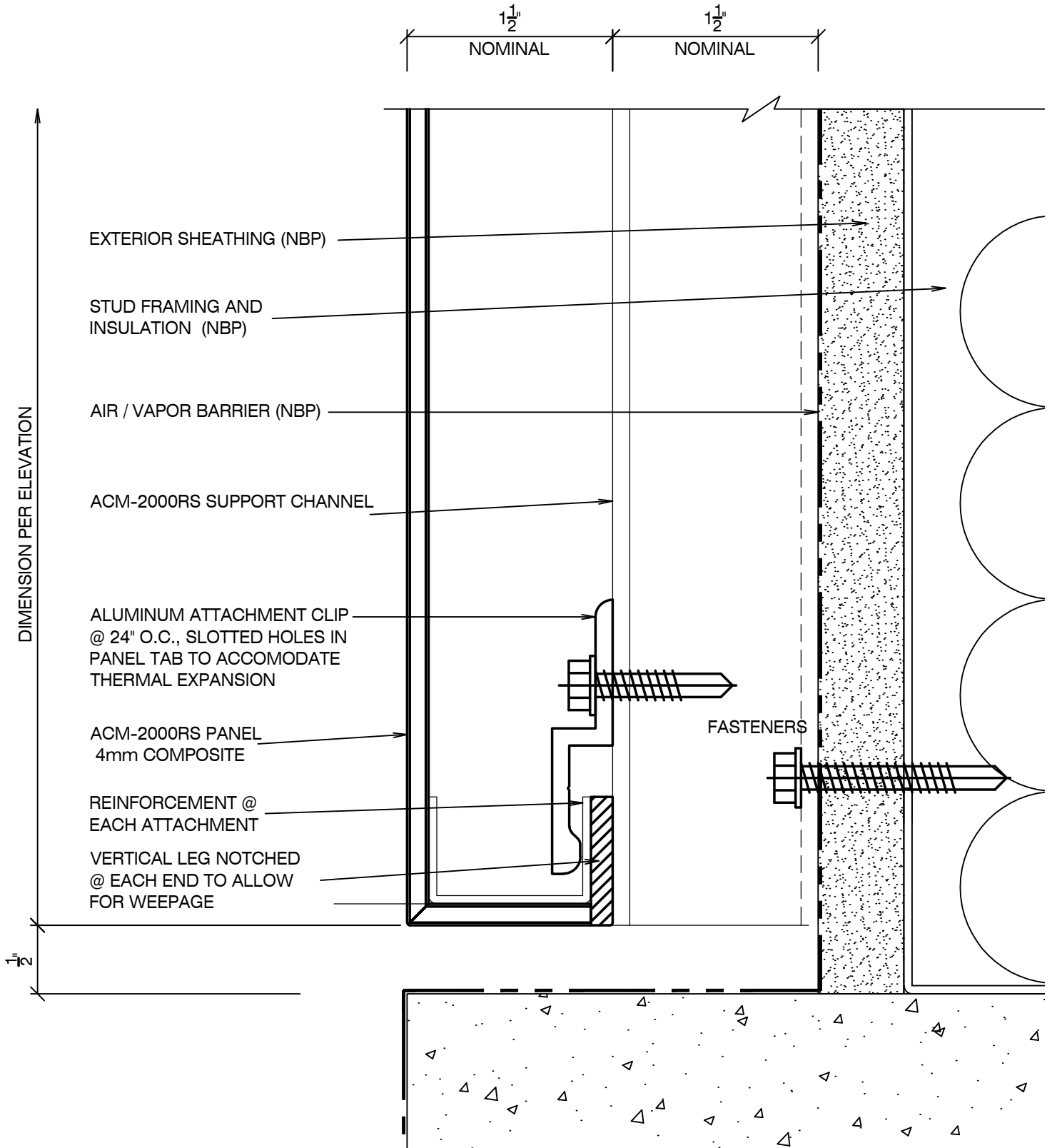

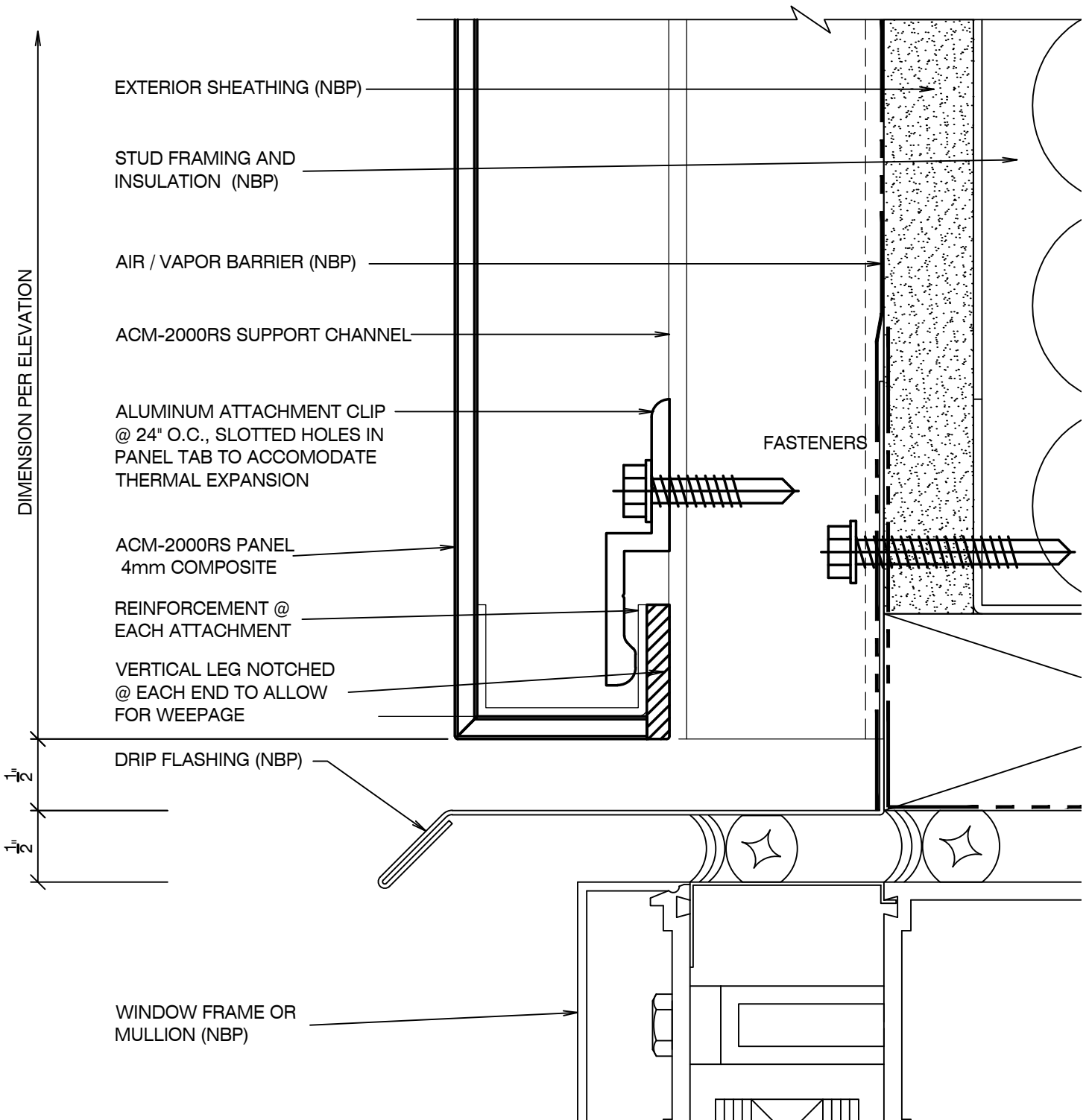
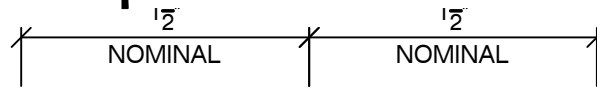

Construction Products, Inc.

Typical Window Sill Detail

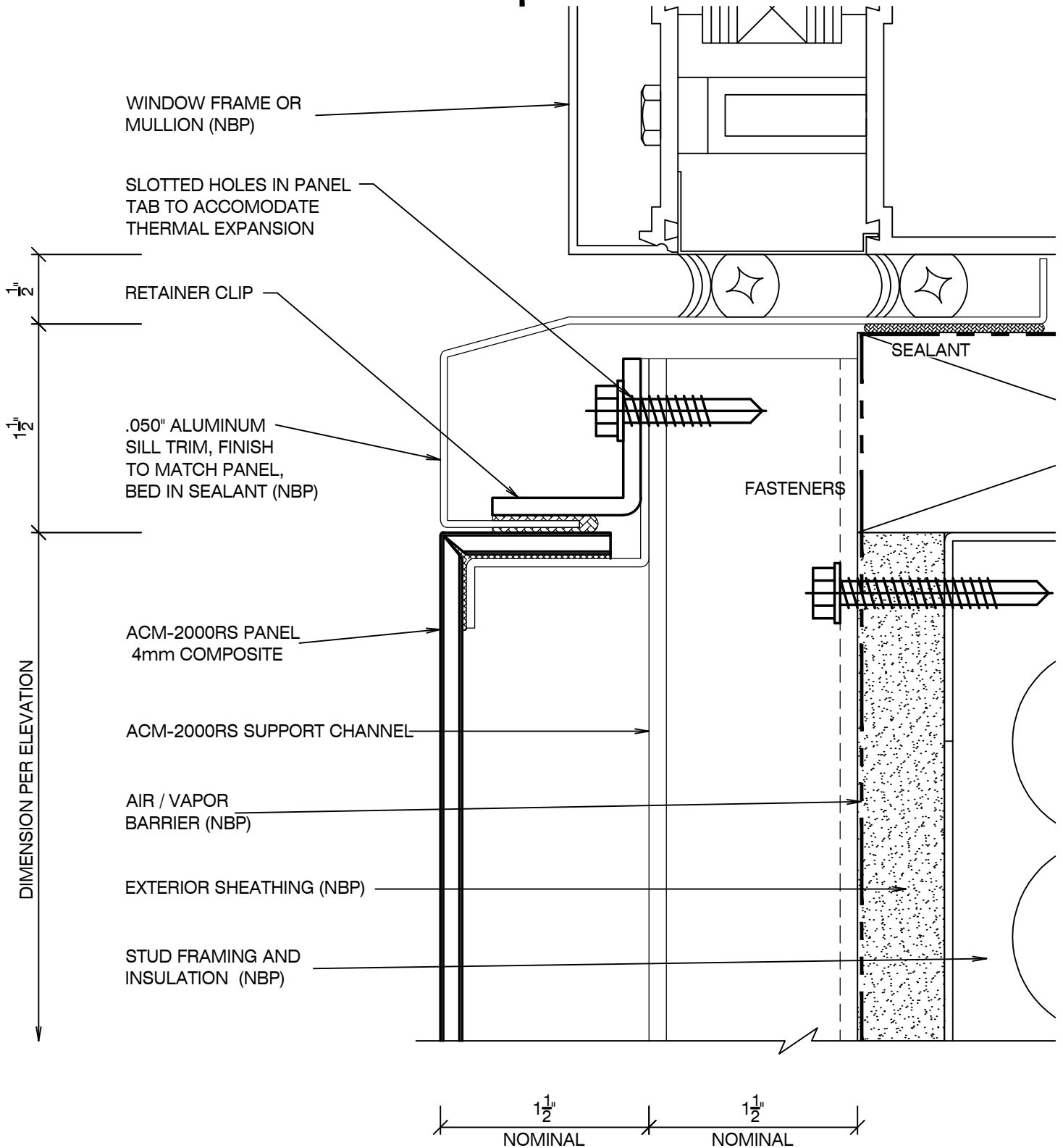

Construction Products, Inc.

Typical Window Jamb Detail

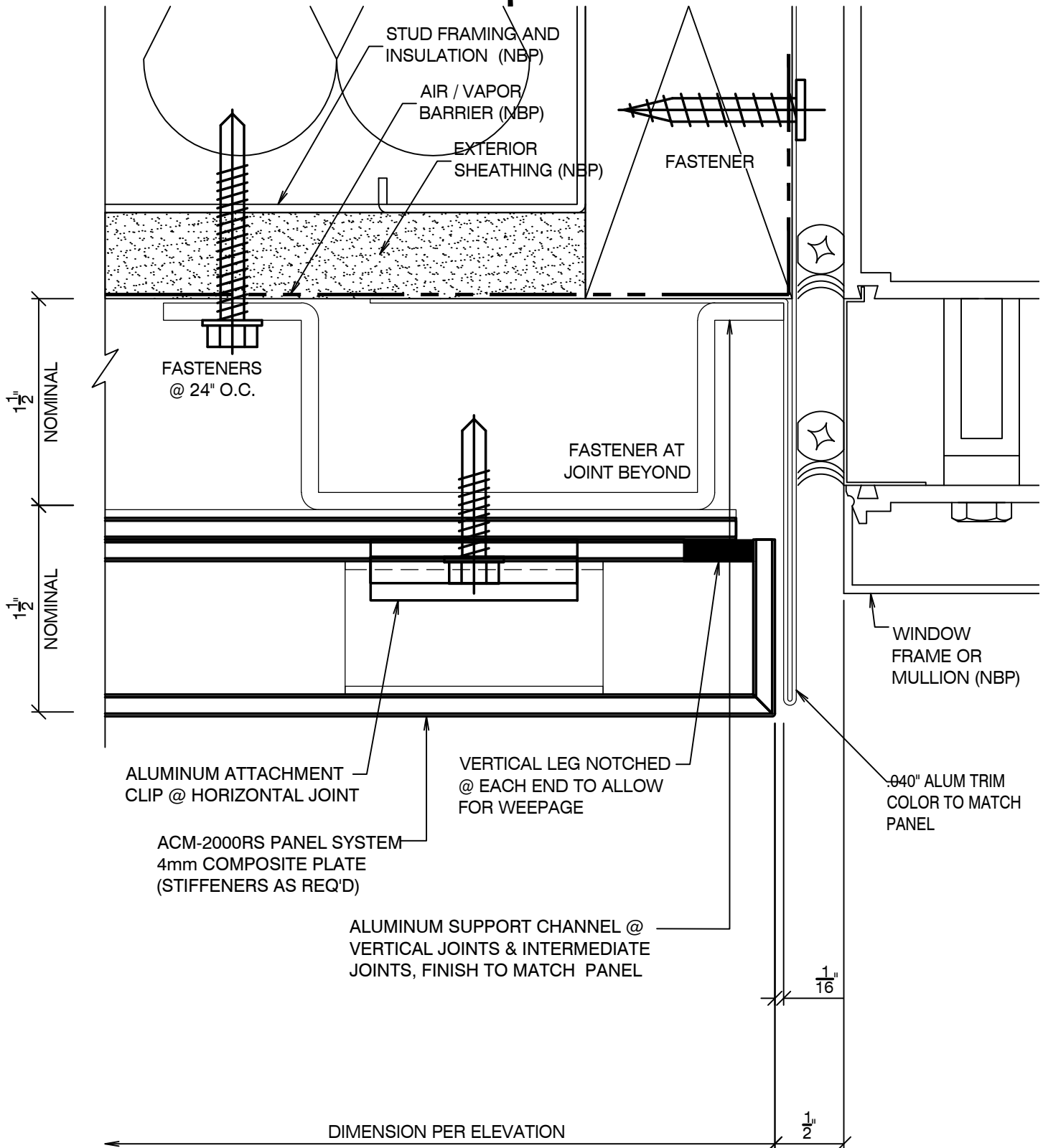

Construction Products, Inc.

Typical Jamb Detail

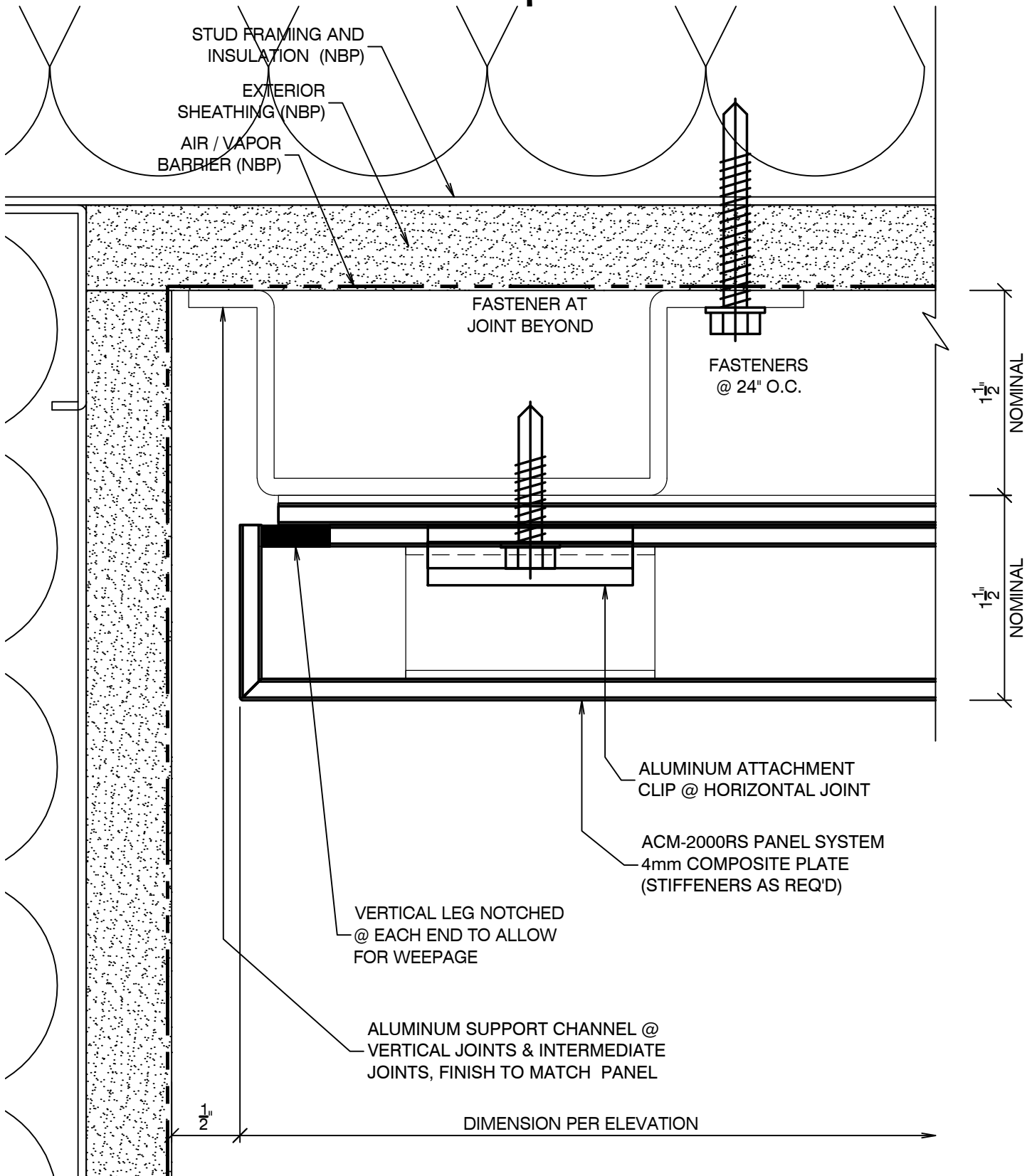

Construction Products, Inc.

Vertical Joint Detail

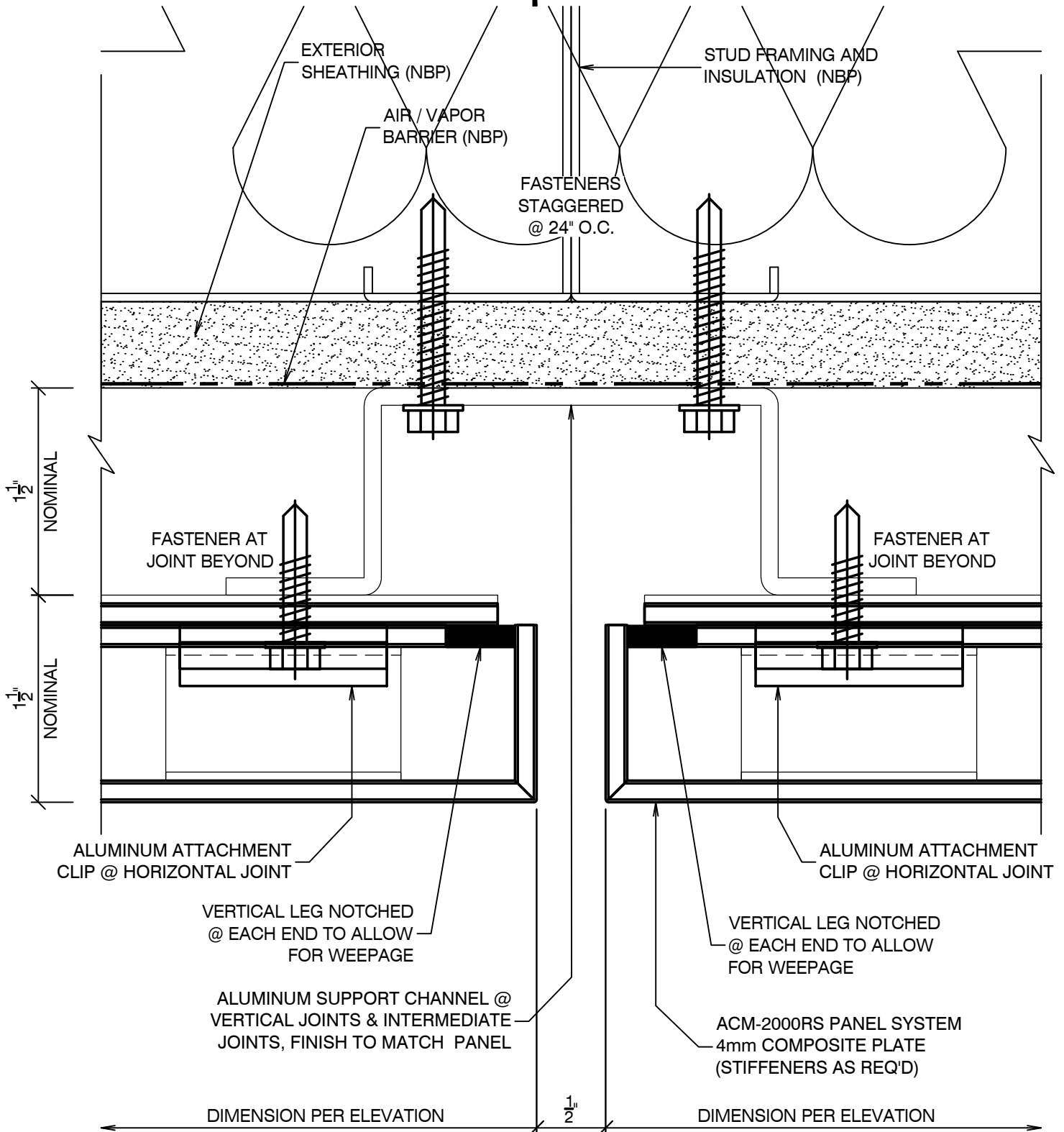

Construction Products, Inc.

Bent Outside Corner

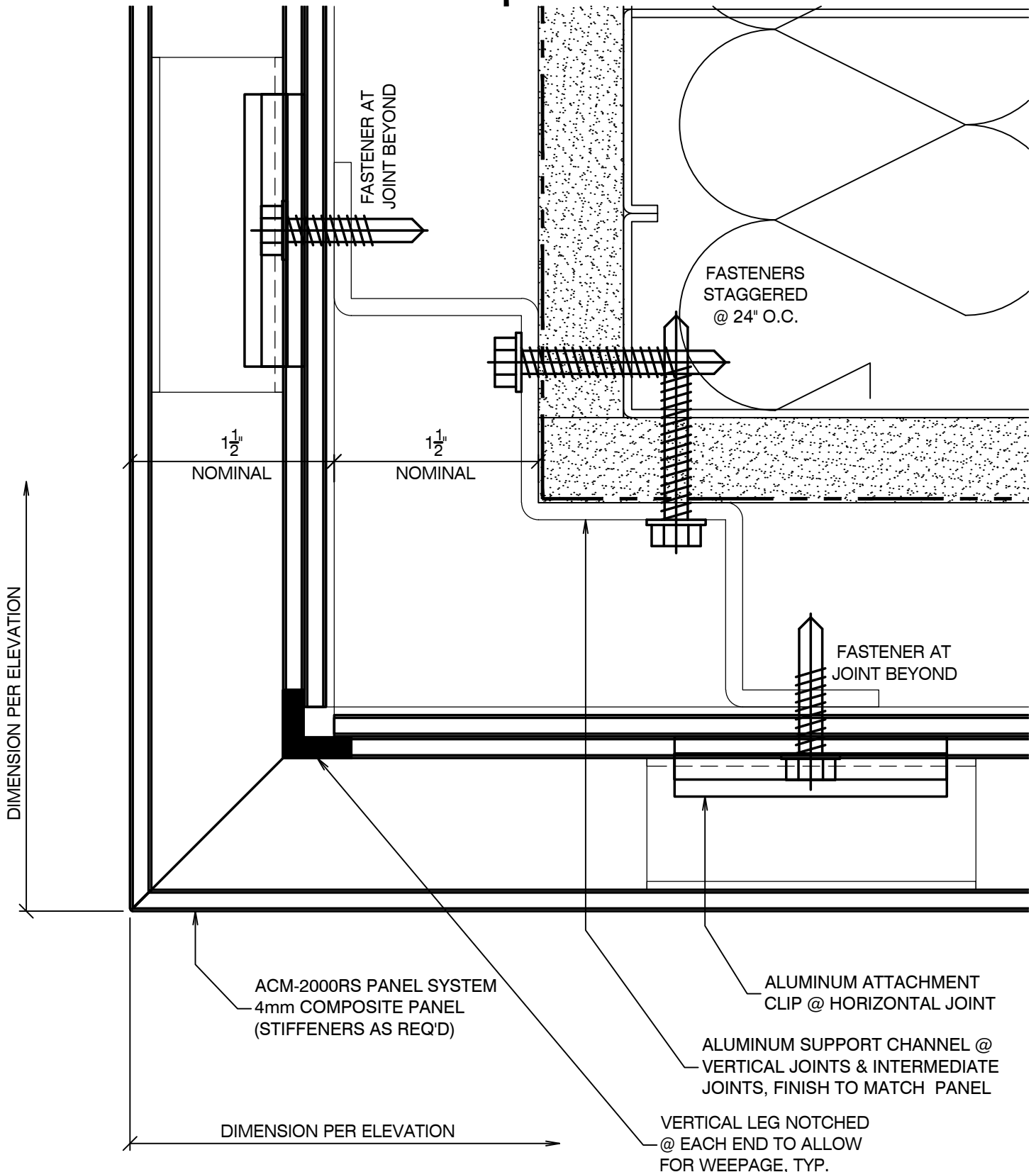

Construction Products, Inc.

Mitered Outside Corner

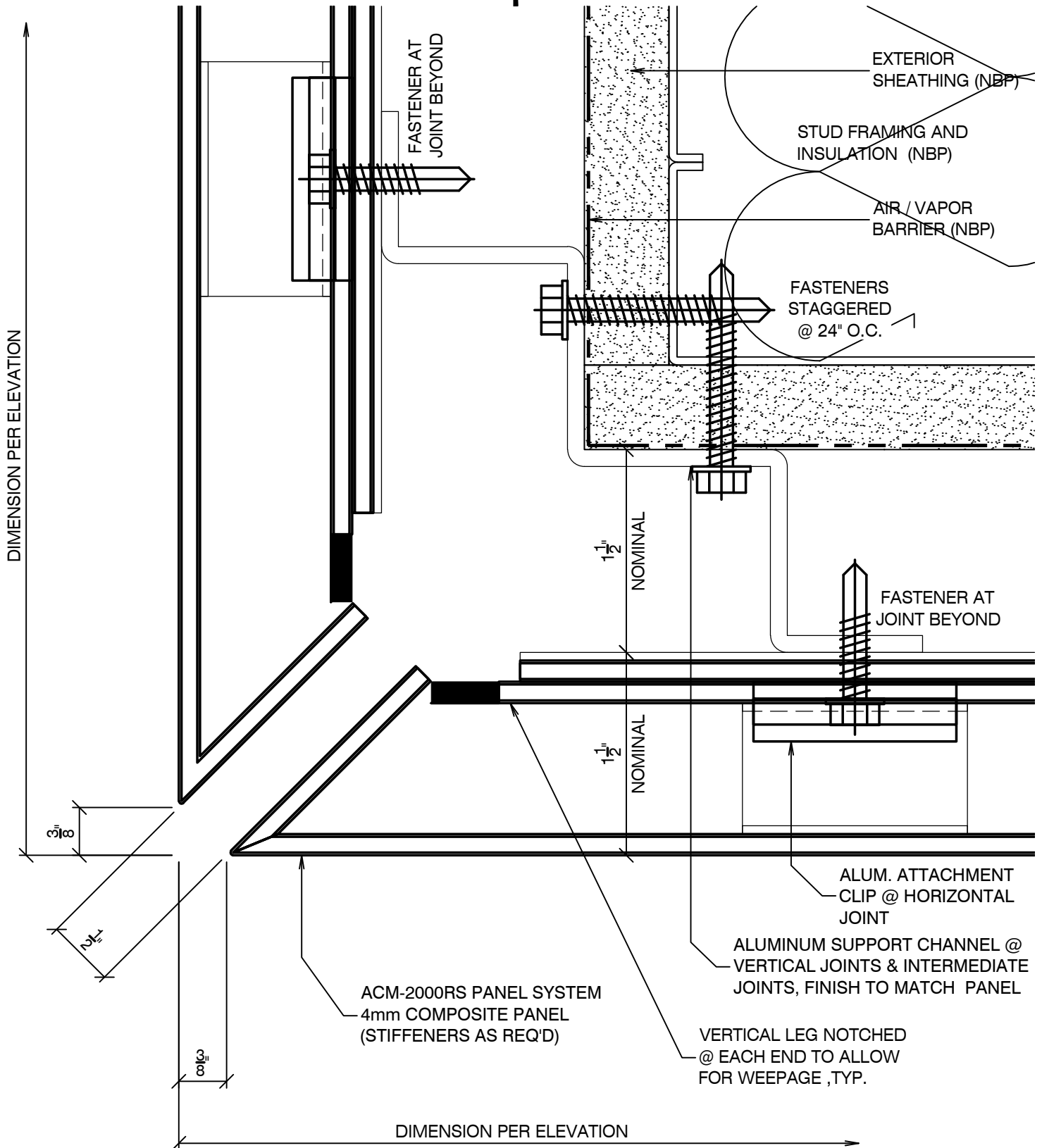

Construction Products, Inc.

Bent Inside Corner

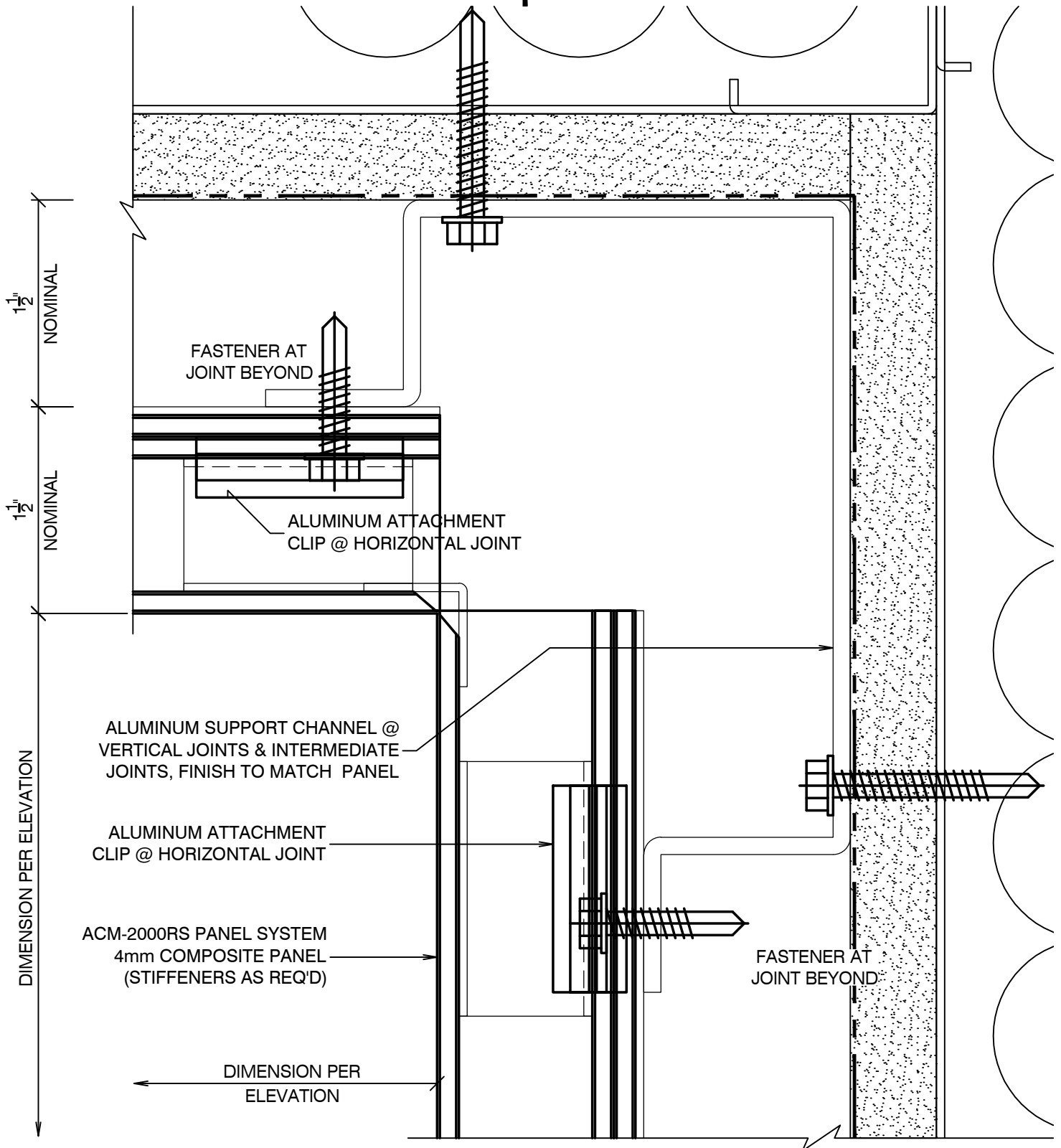

Construction Products, Inc.

Inside Corner

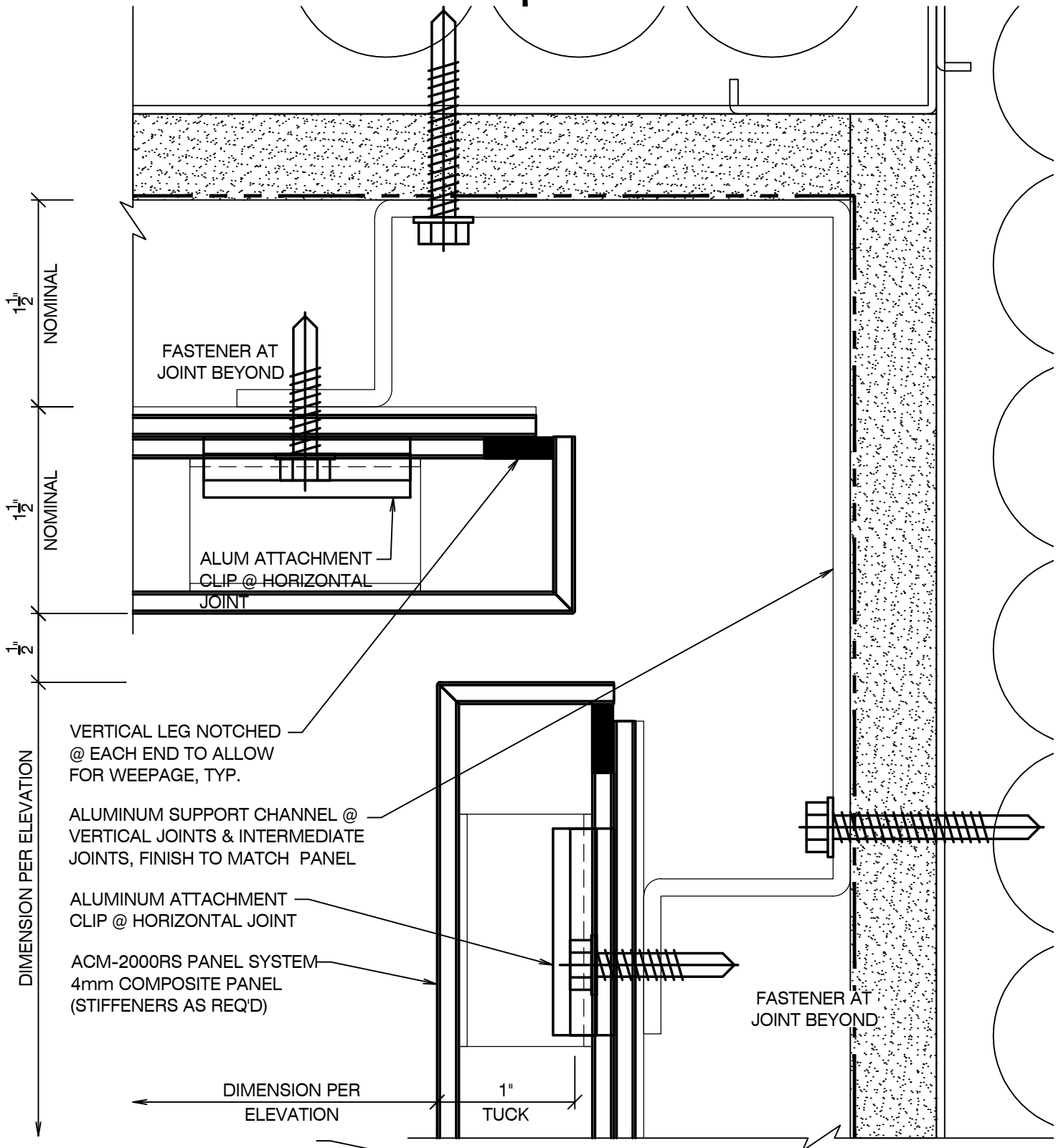

Construction Products, Inc.

?

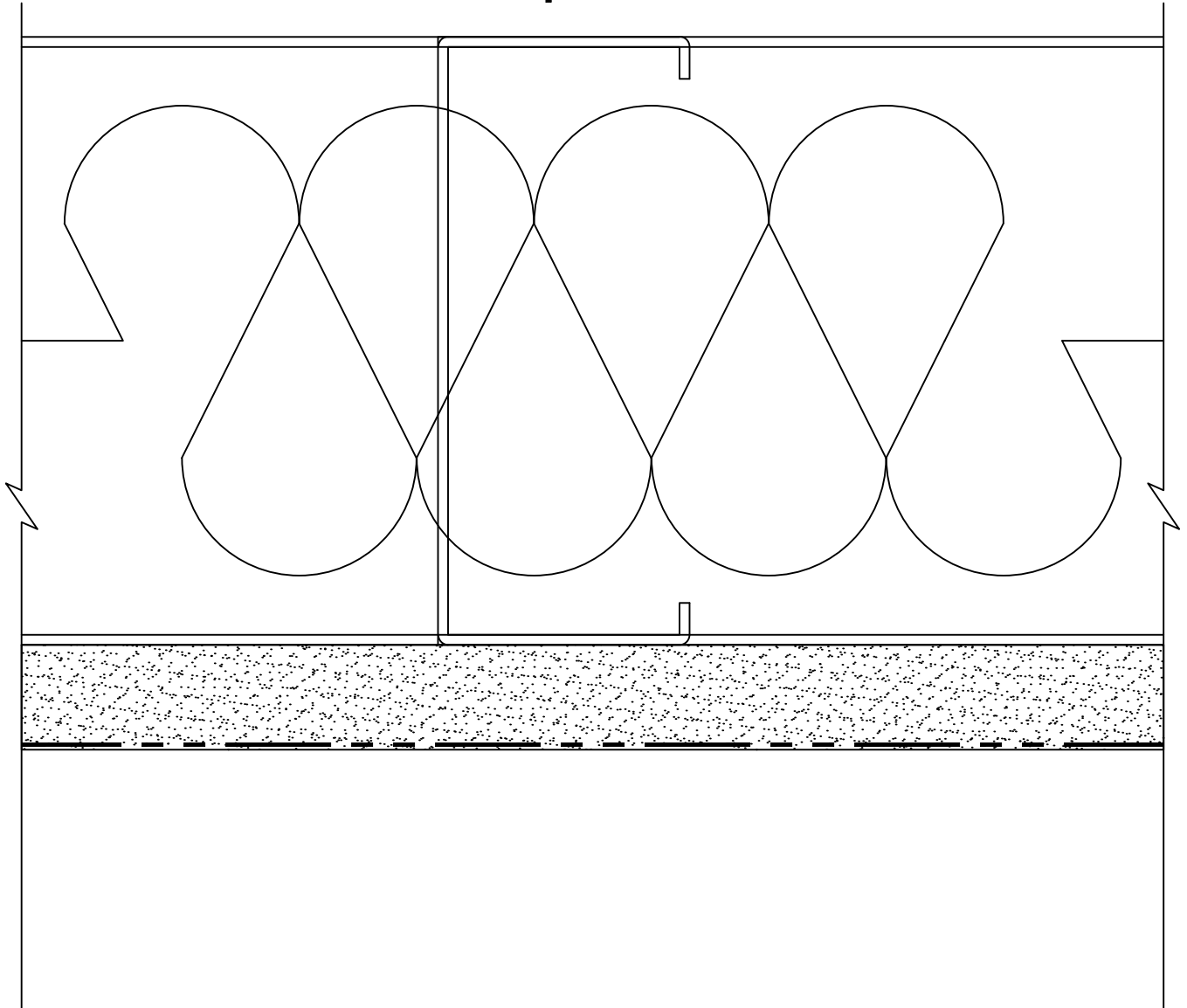

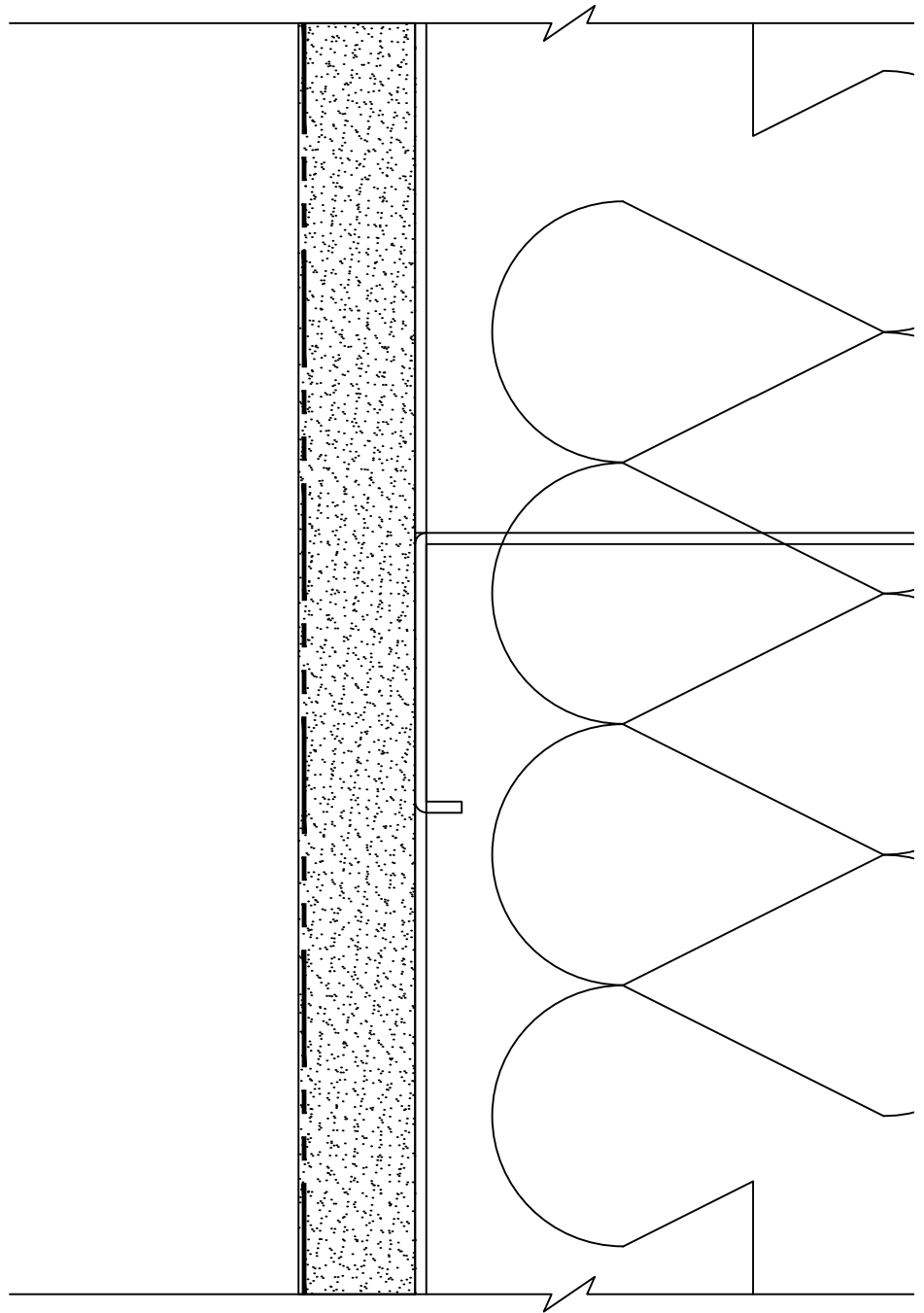

Prōtean

Composite Rainscreen ACM-2000RS
Standard Details

Construction Products, Inc.

?

Prōtean

Composite Rainscreen ACM-2000RS
Standard Details

Construction Products, Inc.

?

Prōtean

Composite Rainscreen ACM-2000RS
Standard Details

Construction Products, Inc.

?

Prōtean

Composite Rainscreen ACM-2000RS
Standard Details

Construction Products, Inc.

?