

1. Most details included herein are drawn to full scale.
2. Details shown herein, illustrate 2" deep system of 4mm Composite Material column covers. Other system depths and plate thickness are available. Refer to other sections of this literature for additional options or consult Protean for any special requirements.
3. In general, panel attachment should be made along the long edge of the panels.
4. Details as shown herein illustrate a vertical installation with subgirts running vertically and panel attachment located at the vertical joints.
5. The enclosed details represent typical standard details for the Composite column covers. This is only the beginning of the possibilities. Consult Protean for assistance in developing custom details for your application.
6. For 4mm Composite, minimum radius of 4" and maximum length of 15'-0". For all other material, consult Protean Construction Products for further information.

Construction Products, Inc.

REFERENCE SHEET

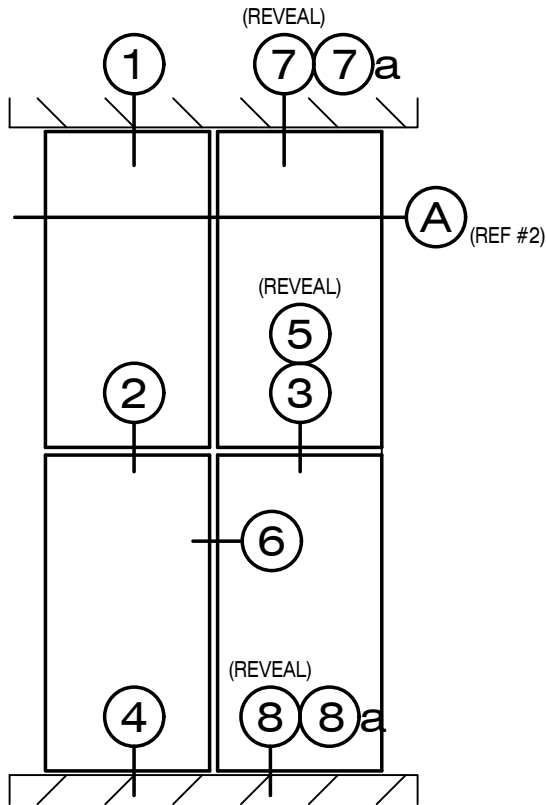

SQUARE

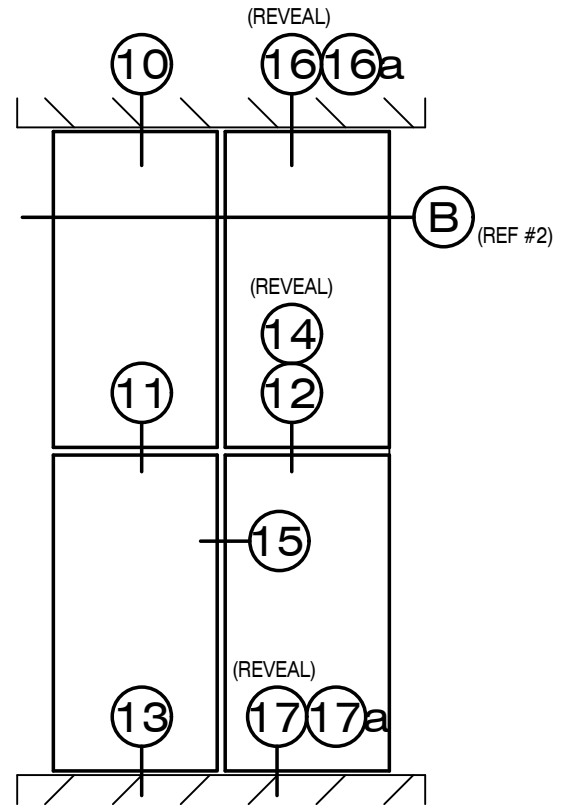

RADIUS

INDEX

<u>SHEET #</u>	<u>DESCRIPTION</u>	<u>SHEET #</u>	<u>DESCRIPTION</u>
ACM-COL-300 / 1	HEAD JOINT	ACM-COL-300 / 10	HEAD JOINT
ACM-COL-300 / 2	HORIZONTAL SPLICE	ACM-COL-300 / 11	HORIZONTAL SPLICE
ACM-COL-300 / 3	HORIZONTAL JOINT	ACM-COL-300 / 12	HORIZONTAL JOINT
ACM-COL-300 / 4	BASE JOINT	ACM-COL-300 / 13	BASE JOINT
ACM-COL-300 / 5	HORIZONTAL REVEAL JOINT	ACM-COL-300 / 14	HORIZONTAL REVEAL JOINT
ACM-COL-300 / 6	VERTICAL JOINT	ACM-COL-300 / 15	VERTICAL JOINT
ACM-COL-100 / 7	HEAD REVEAL JOINT	ACM-COL-100 / 16	HEAD REVEAL JOINT
ACM-COL-100 / 7a	ALT. HEAD REVEAL JOINT	ACM-COL-100 / 16a	ALT. HEAD REVEAL JOINT
ACM-COL-100 / 8	BASE REVEAL JOINT	ACM-COL-100 / 17	BASE REVEAL JOINT
ACM-COL-100 / 8a	ALT. BASE REVEAL JOINT	ACM-COL-100 / 17a	ALT. BASE REVEAL JOINT

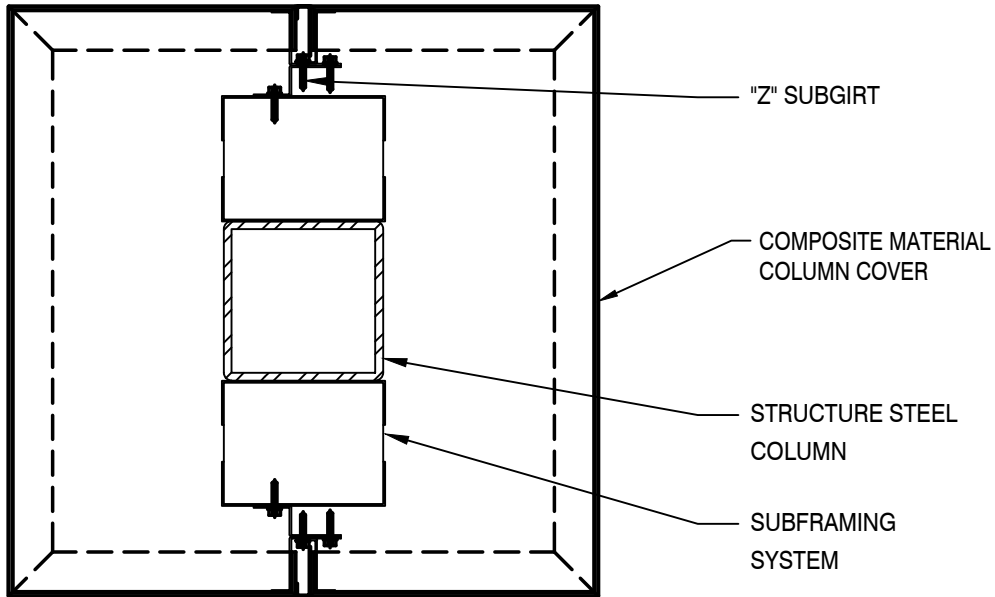

SECTION A

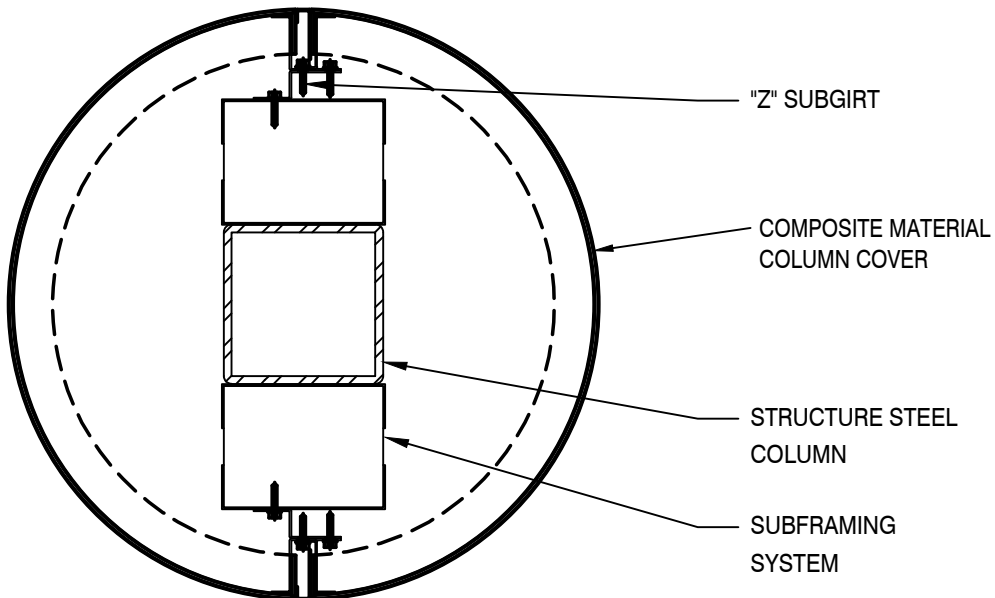

SECTION B

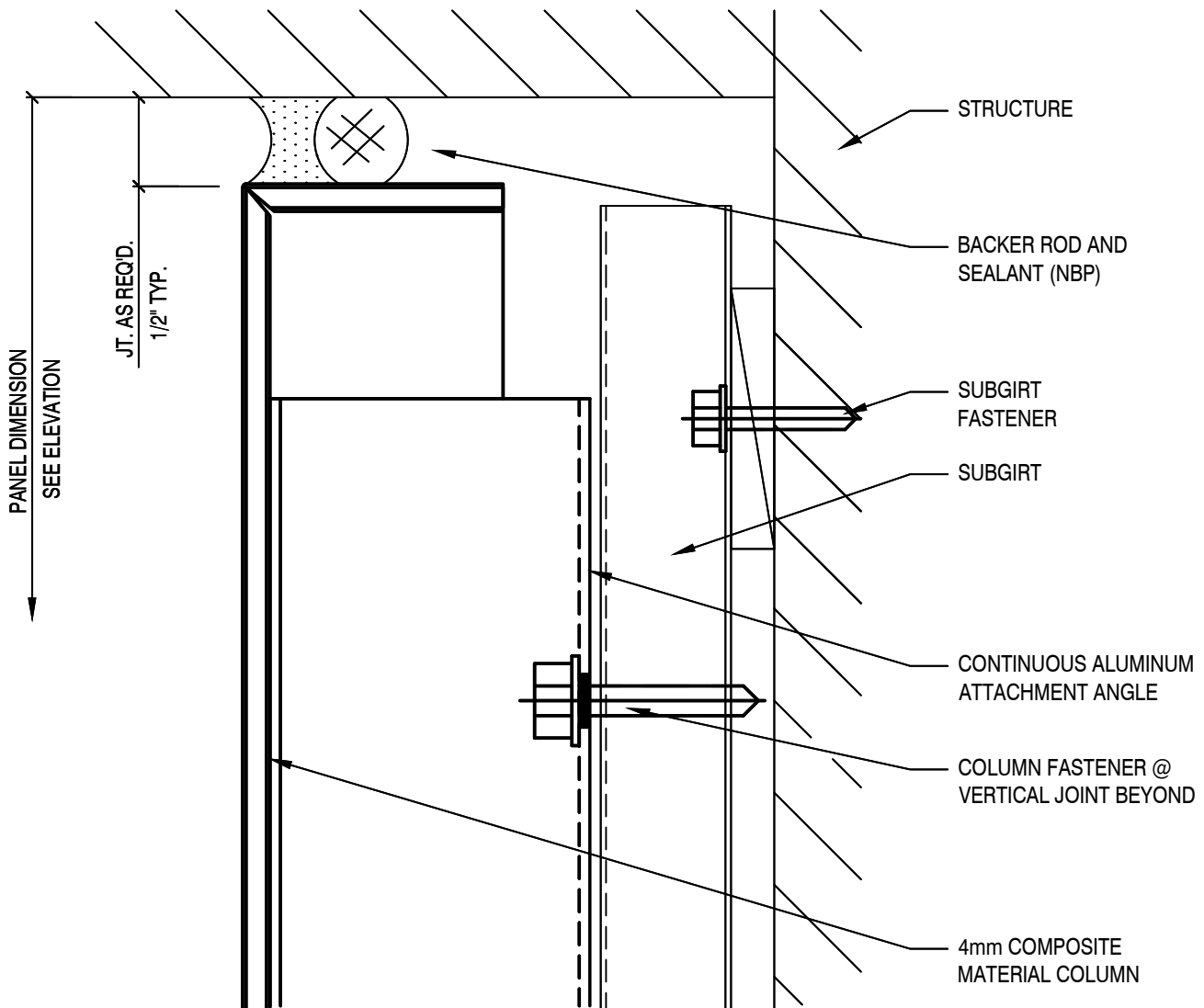

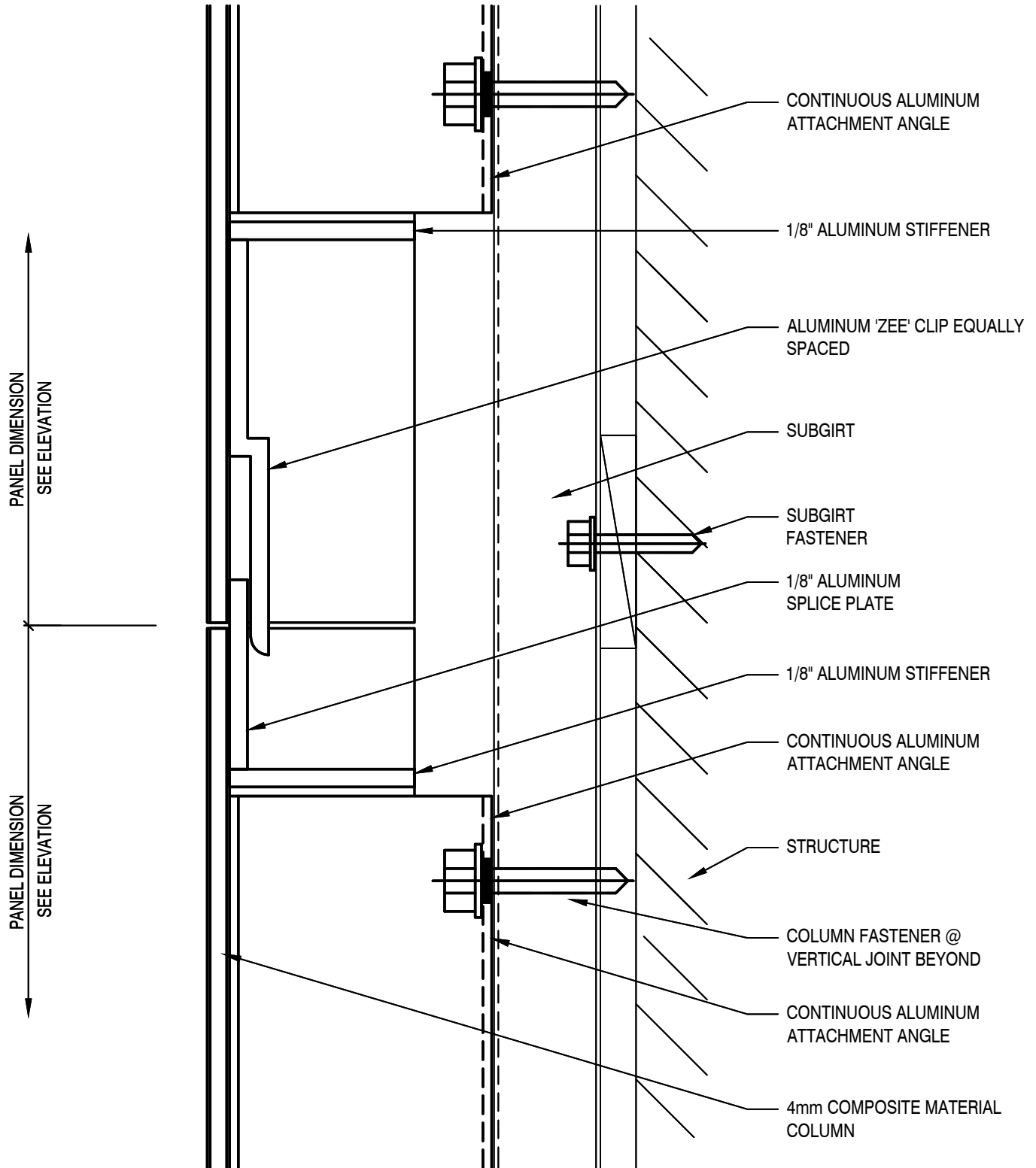

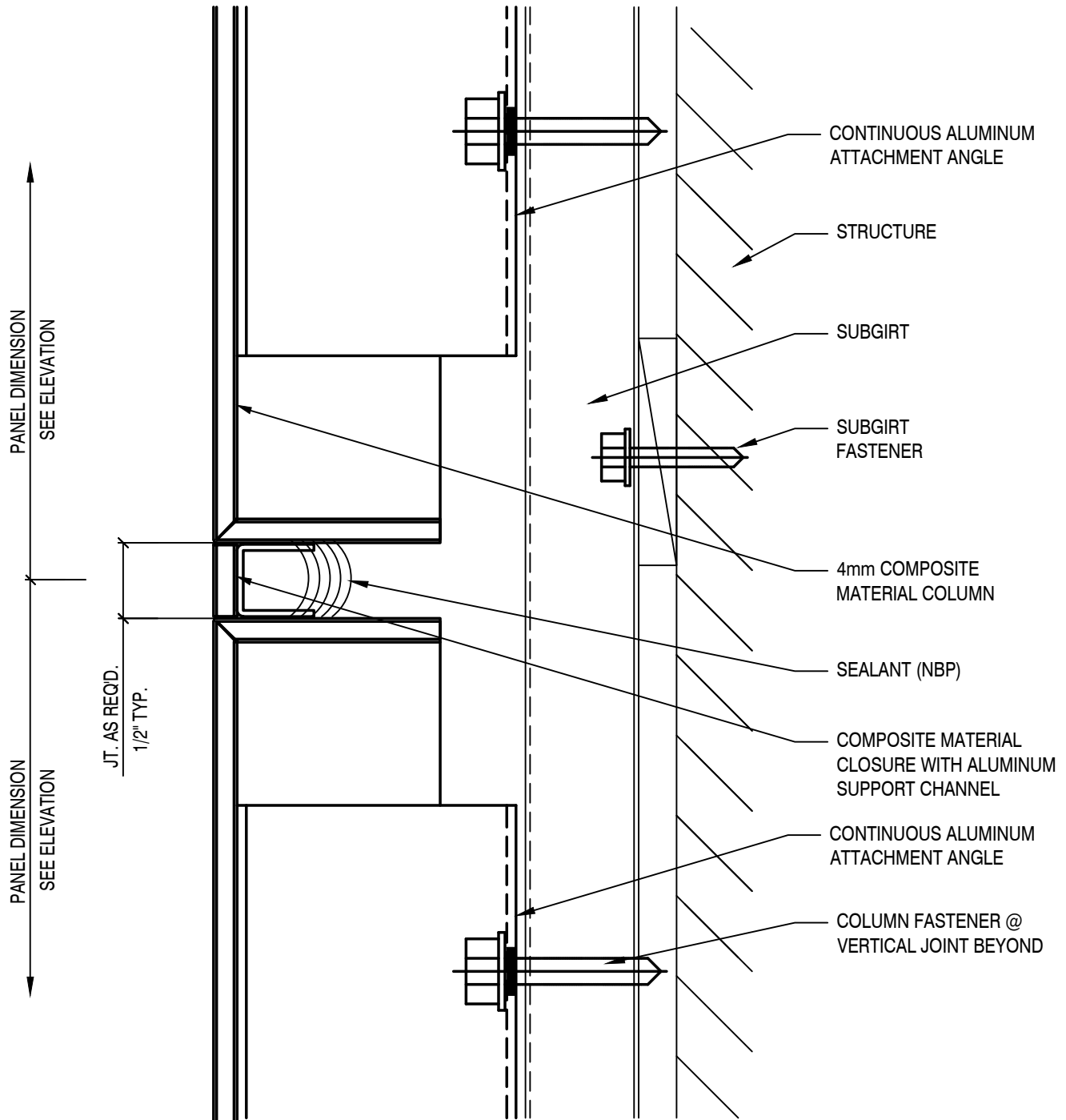

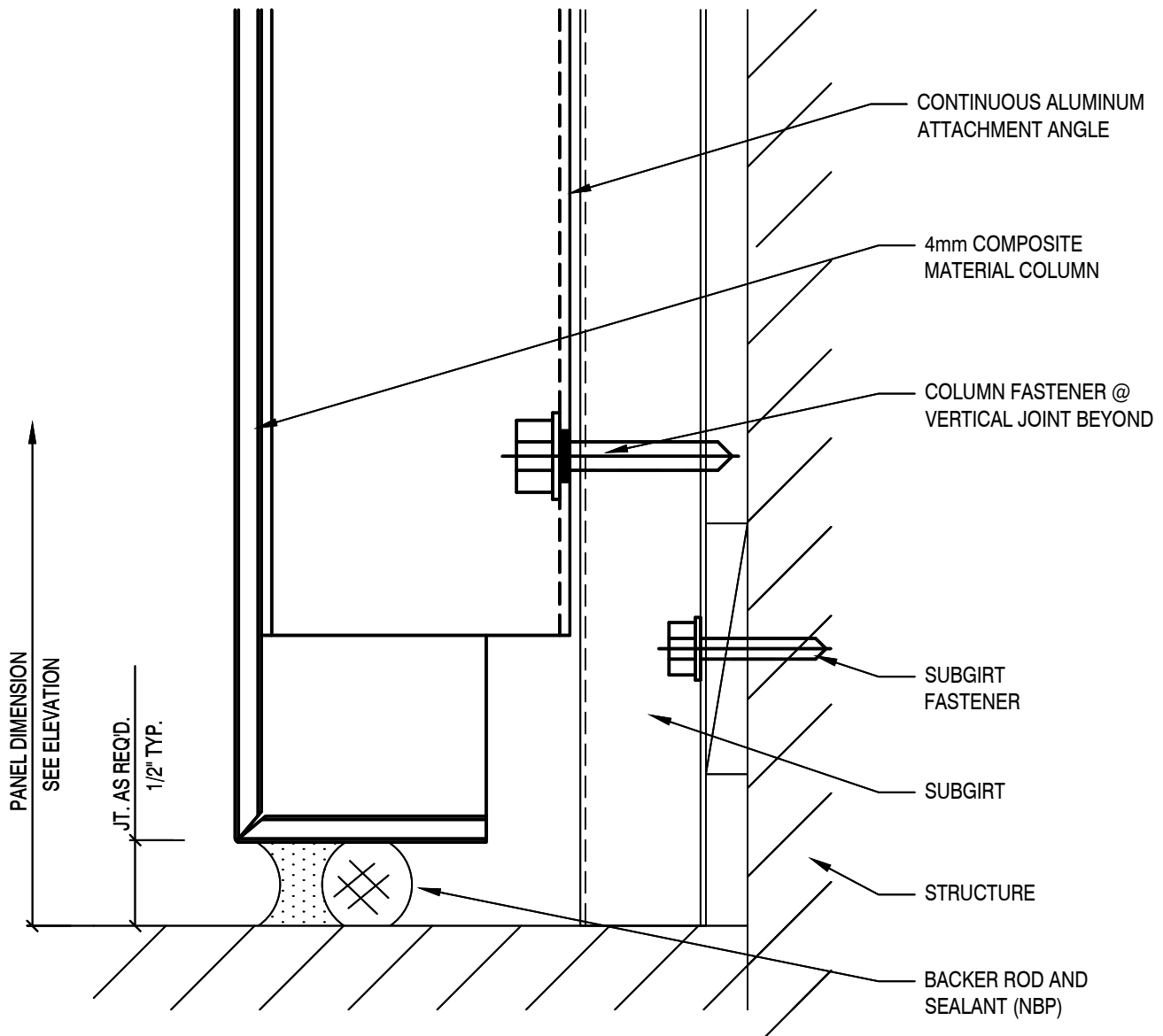

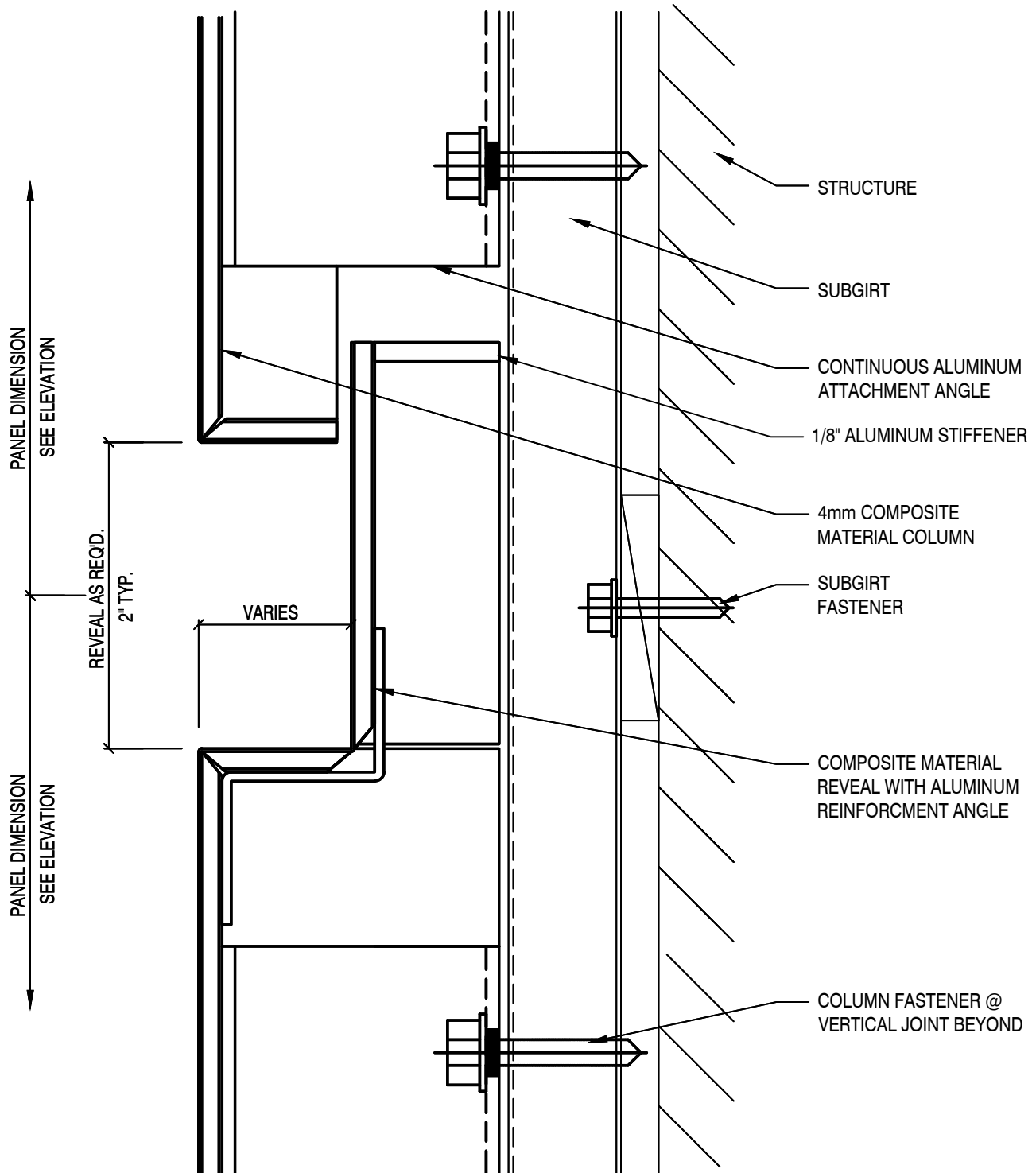

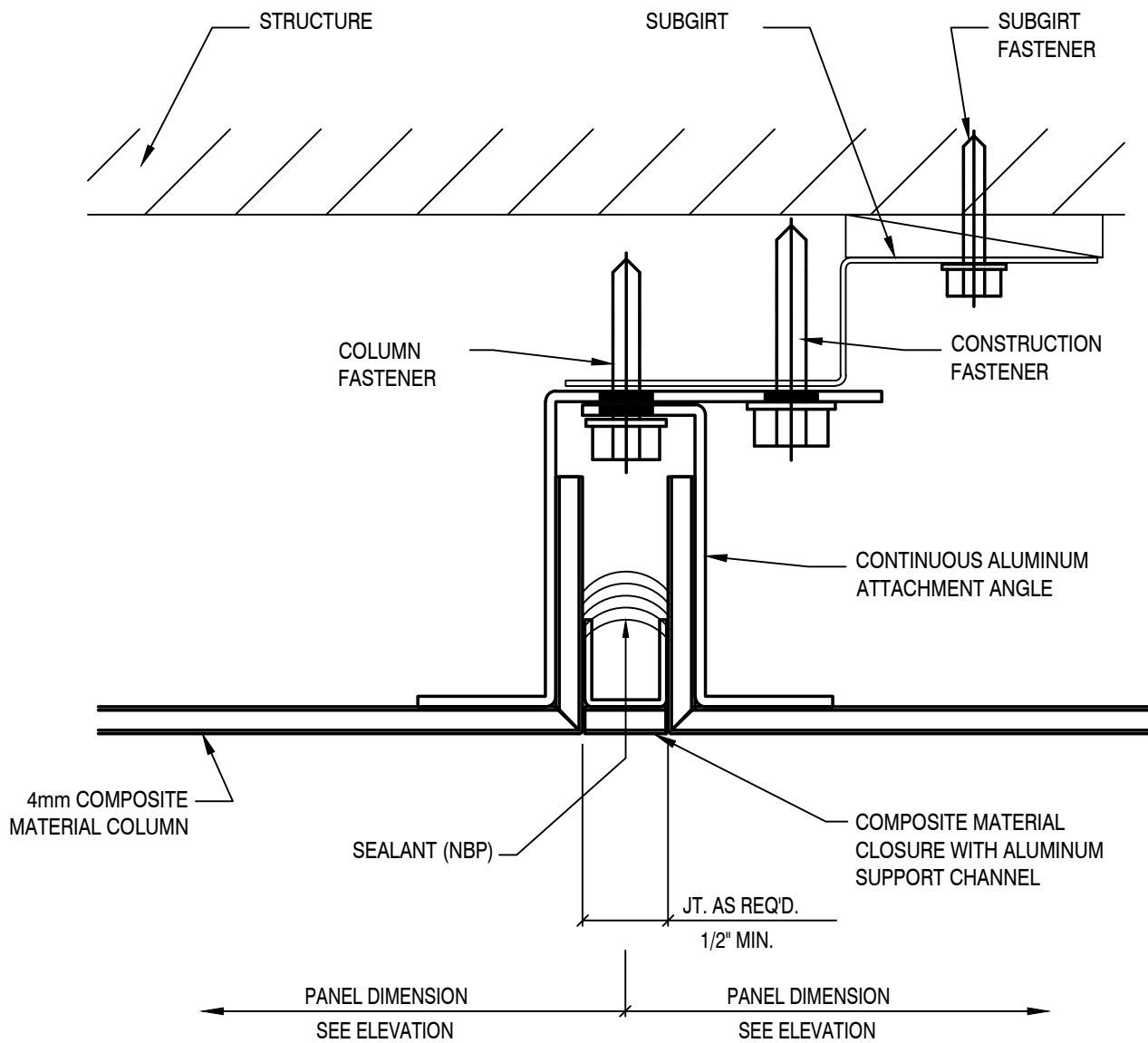

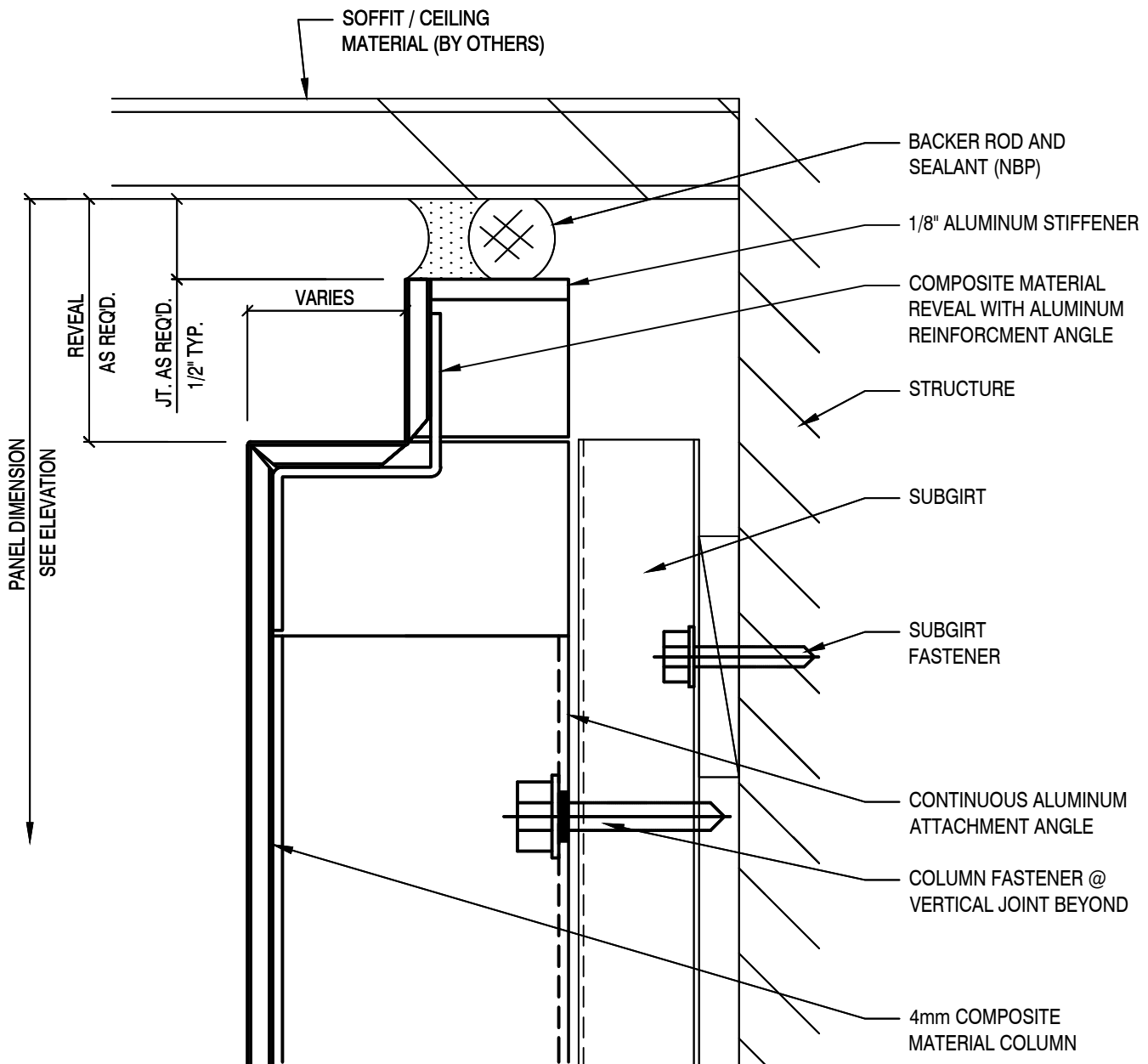

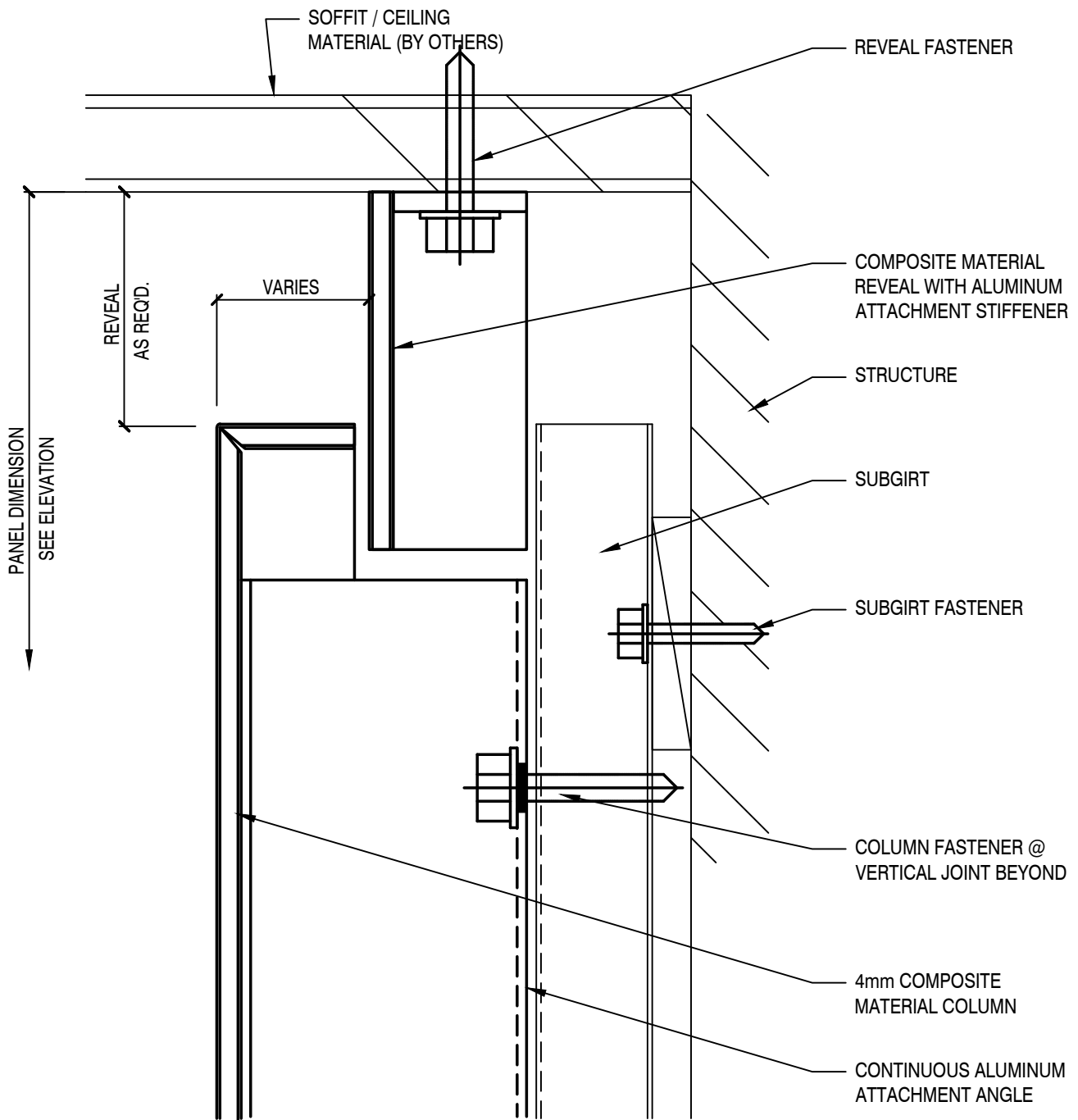

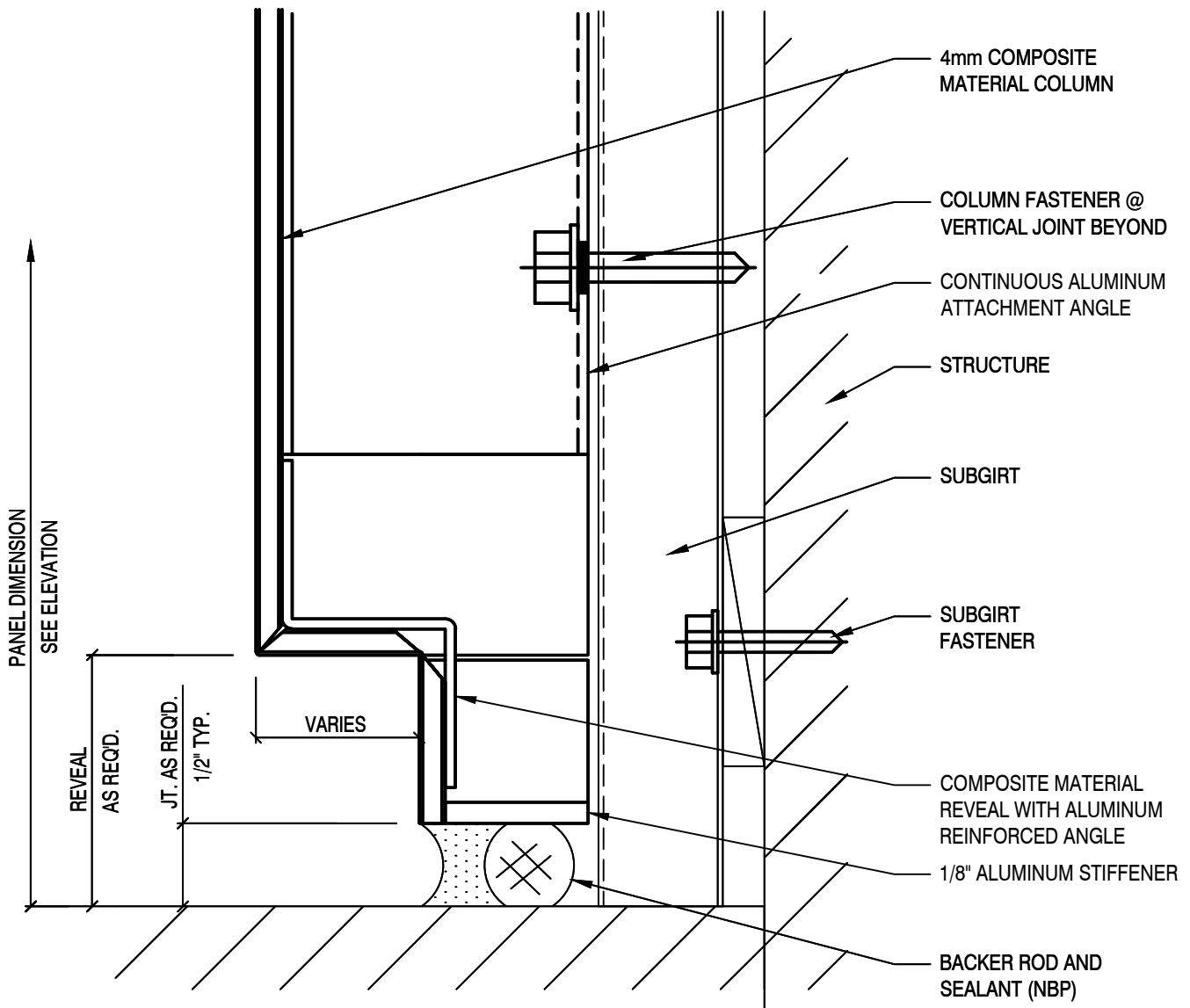

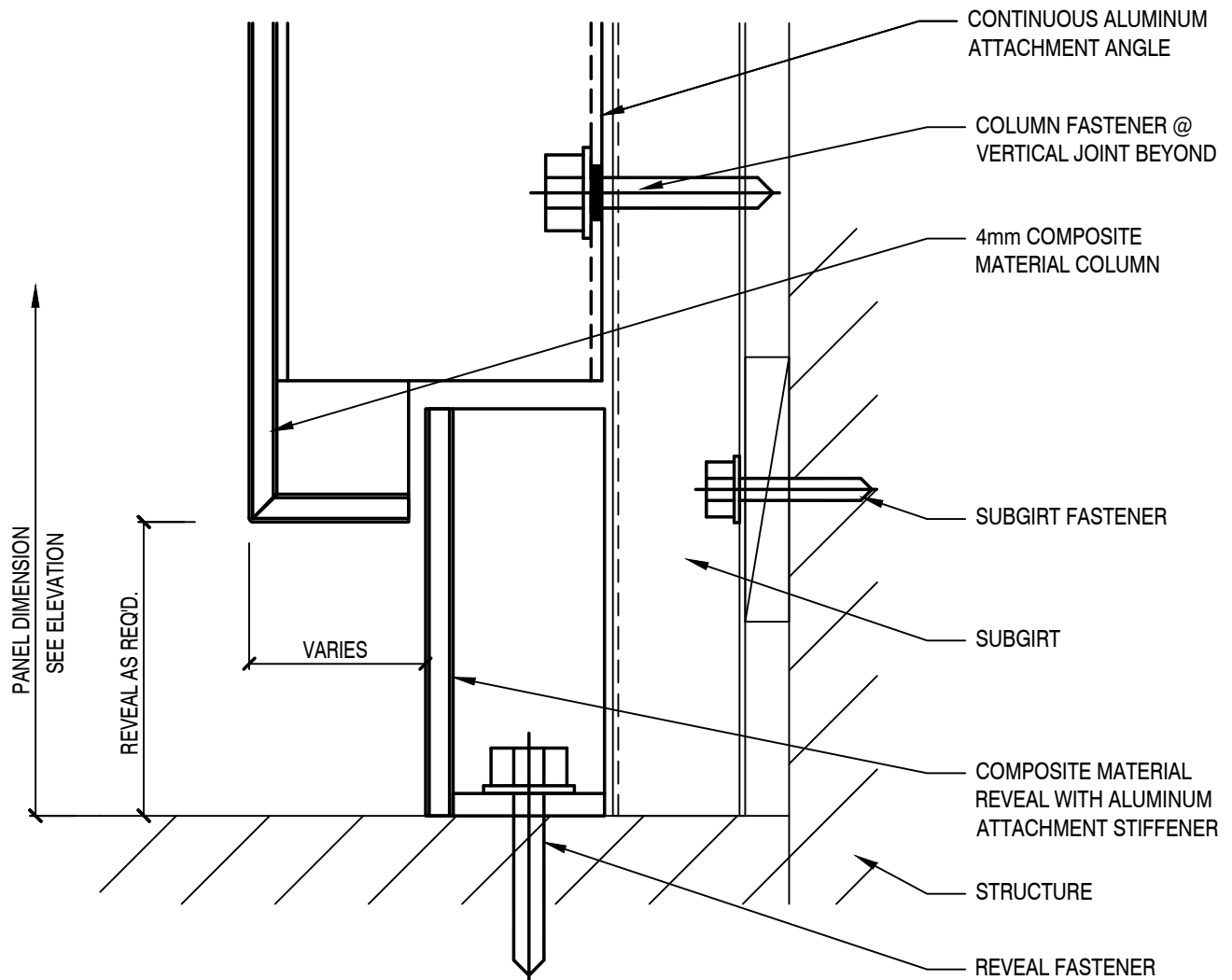

Prōtean

ACM-COL-300 Column Covers
Standard Details

Construction Products, Inc.

?

NOT USED

