

1. Most details included herein are drawn to full scale.
2. Details shown herein, illustrate 2" deep system of Stainless Steel column covers. Other system depths and material thicknesses are available. Refer to other sections of this literature for additional options or consult Protean for any special requirements.
3. In general, panel attachment should be made along the long edge of the panels.
4. Details as shown herein illustrate a vertical installation with subgirts running vertically and panel attachment located at the vertical joints.
5. The enclosed details represent typical standard details for the Stainless Steel column covers. This is only the beginning of the possibilities. Consult Protean for assistance in developing custom details for your application.
6. For Stainless Steel, minimum radius of 4" and maximum length of 15'-0". For all other material, consult Protean Construction Products for further information.

Construction Products, Inc.

### REFERENCE SHEET

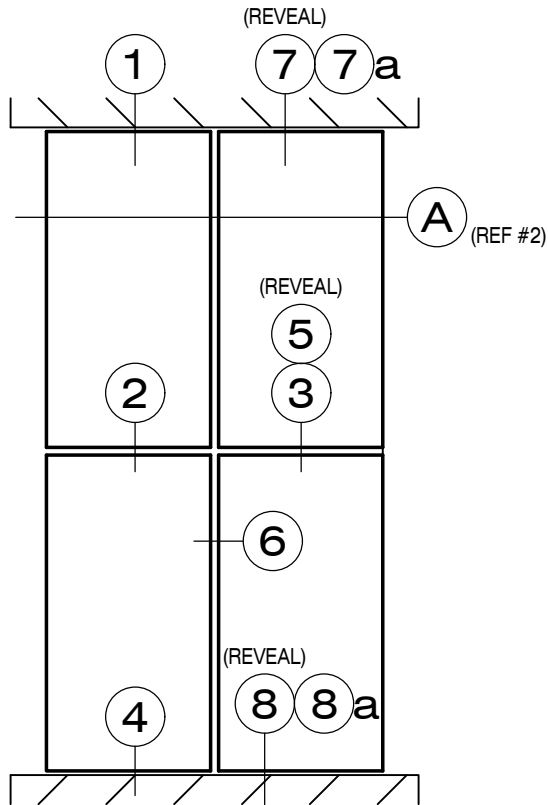

SQUARE

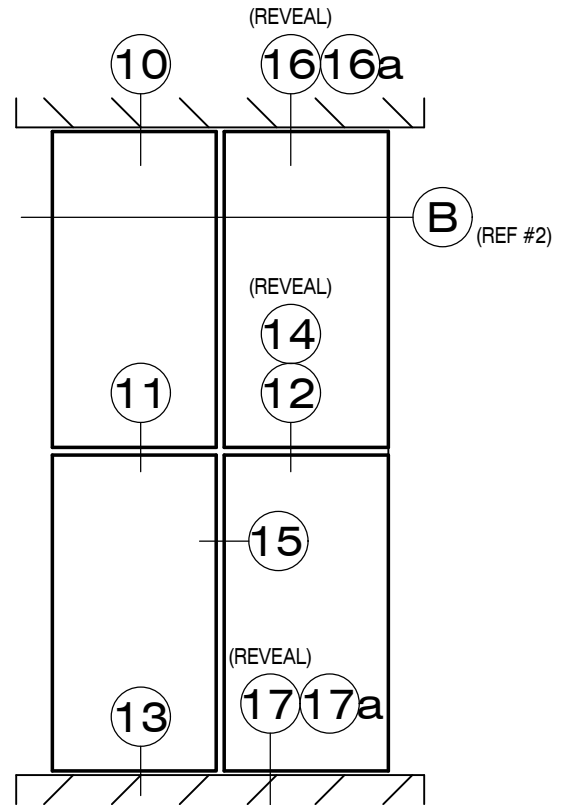

RADIUS

### INDEX

<u>SHEET #</u>	<u>DESCRIPTION</u>	<u>SHEET #</u>	<u>DESCRIPTION</u>
SS-COL-300 / 1	HEAD JOINT	SS-COL-300 / 10	HEAD JOINT
SS-COL-300 / 2	HORIZONTAL SPLICE	SS-COL-300 / 11	HORIZONTAL SPLICE
SS-COL-300 / 3	HORIZONTAL JOINT	SS-COL-300 / 12	HORIZONTAL JOINT
SS-COL-300 / 4	BASE JOINT	SS-COL-300 / 13	BASE JOINT
SS-COL-300 / 5	HORIZONTAL REVEAL JOINT	SS-COL-300 / 14	HORIZONTAL REVEAL JOINT
SS-COL-300 / 6	VERTICAL JOINT	SS-COL-300 / 15	VERTICAL JOINT
SS-COL-300 / 7	HEAD REVEAL JOINT	SS-COL-300 / 16	HEAD REVEAL JOINT
SS-COL-300 / 7a	ALT. HEAD REVEAL JOINT	SS-COL-300 / 16a	ALT. HEAD REVEAL JOINT
SS-COL-300 / 8	BASE REVEAL JOINT	SS-COL-300 / 17	BASE REVEAL JOINT
SS-COL-300 / 8a	ALT. BASE REVEAL JOINT	SS-COL-300 / 17a	ALT. BASE REVEAL JOINT

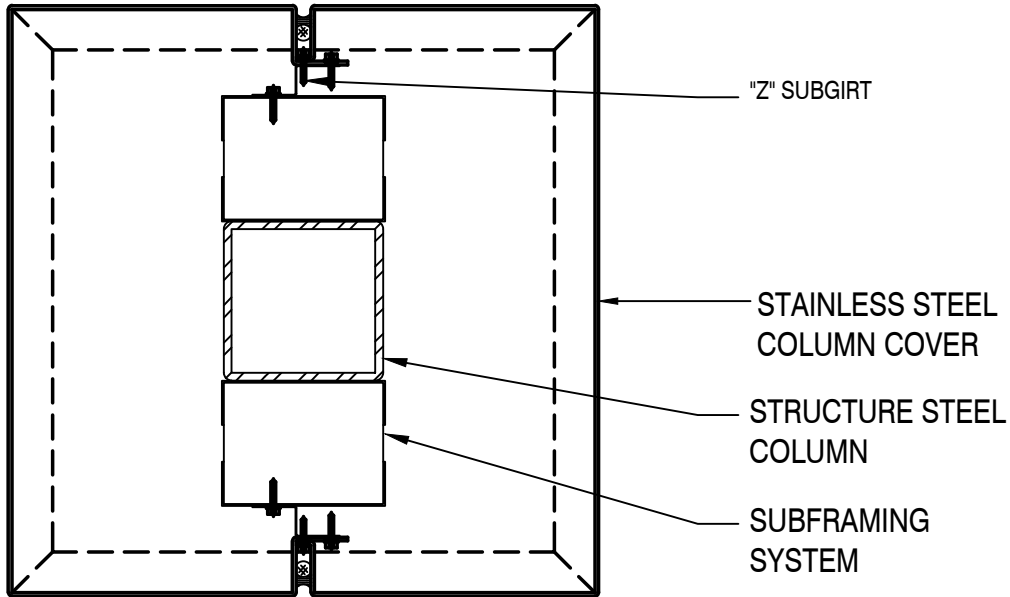

SECTION A

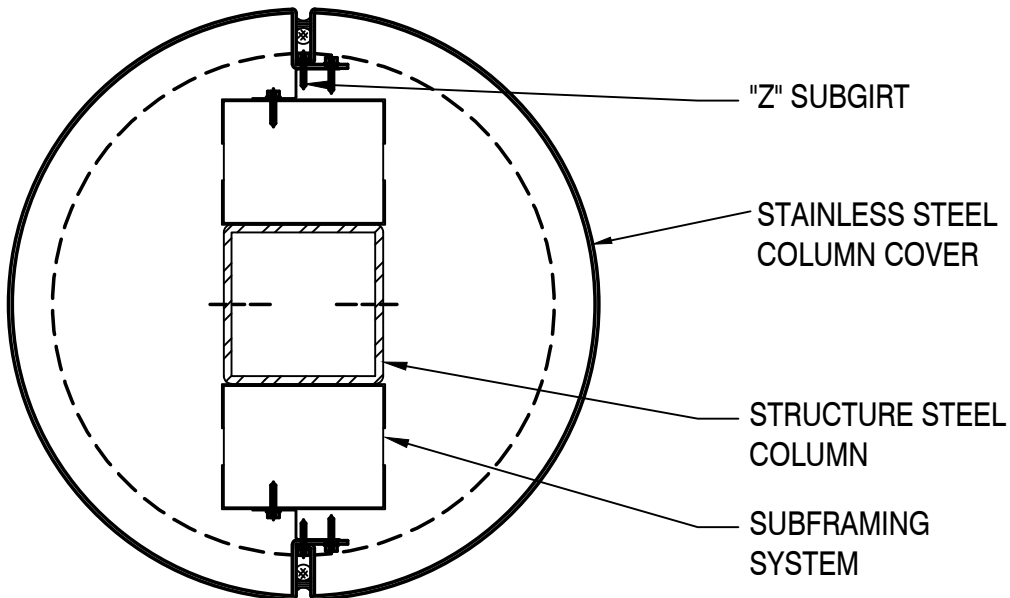

SECTION B

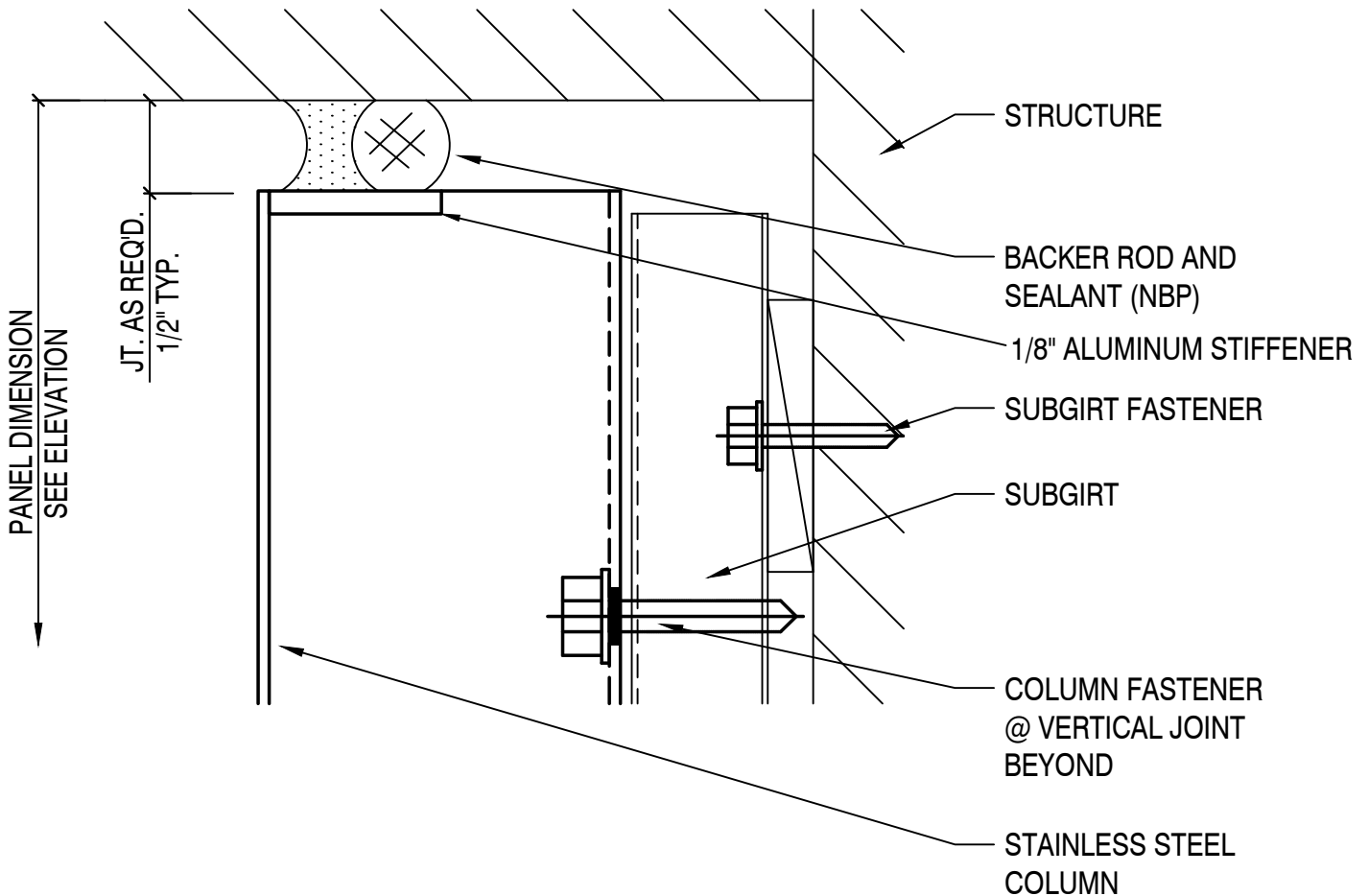

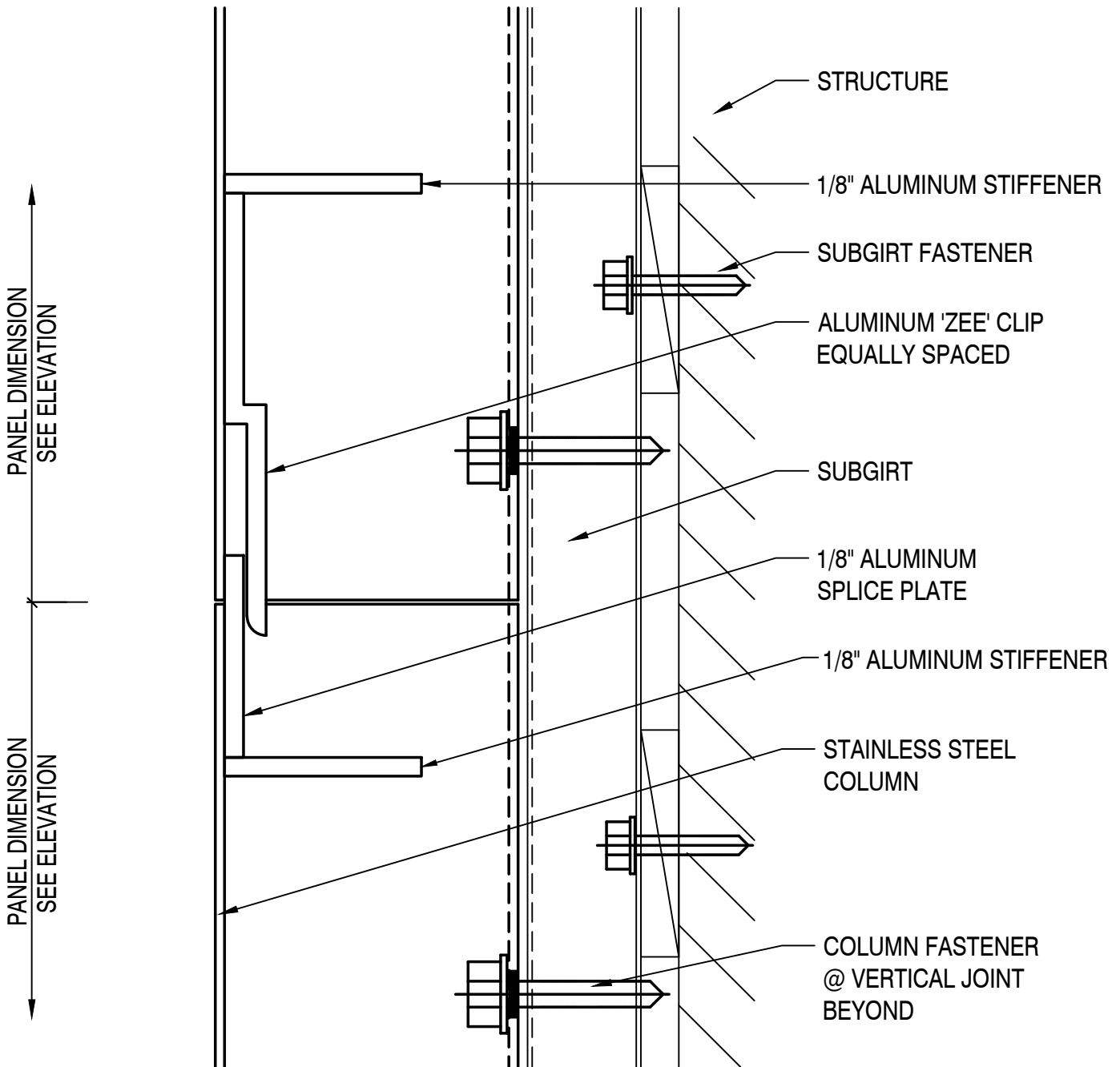

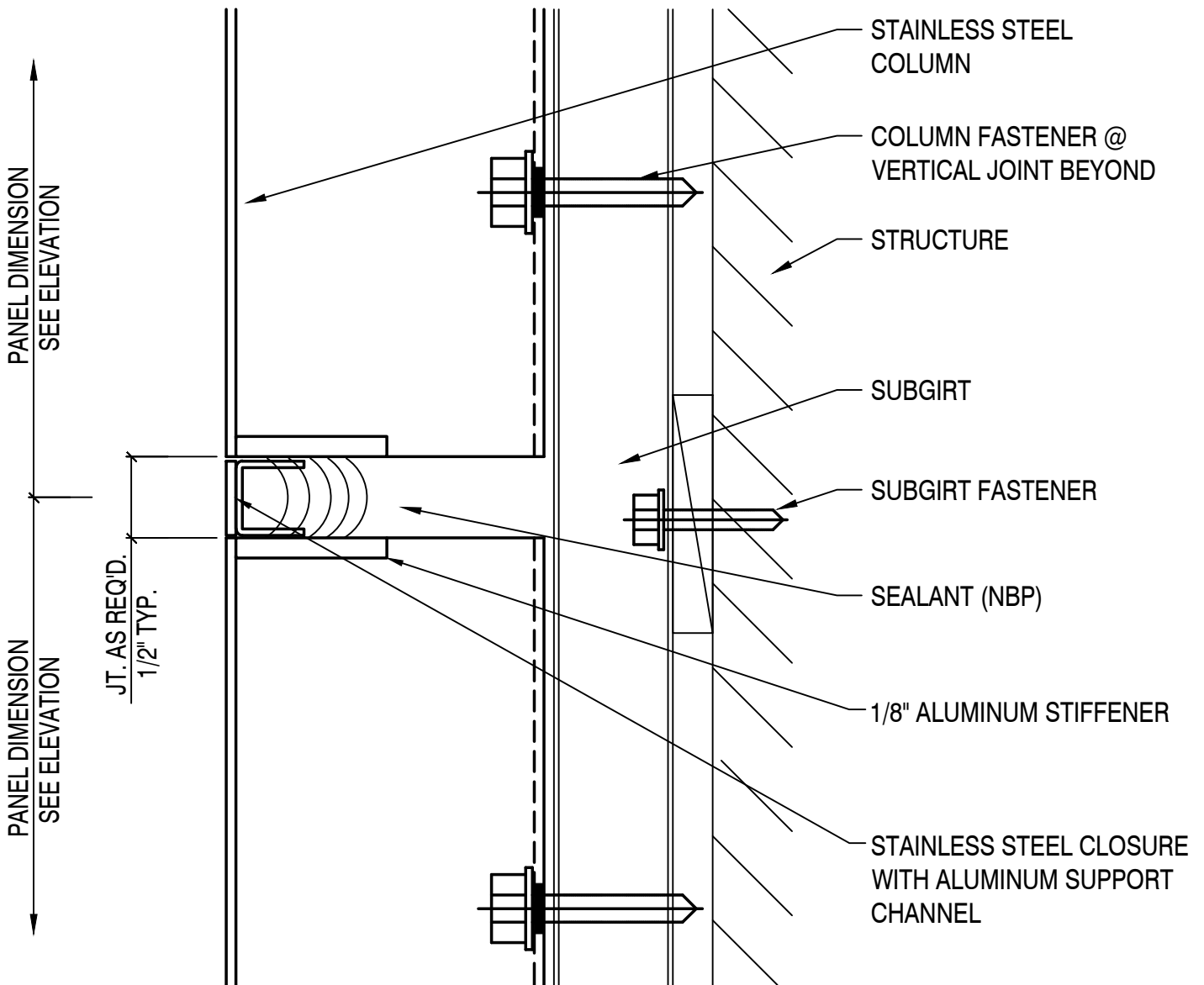

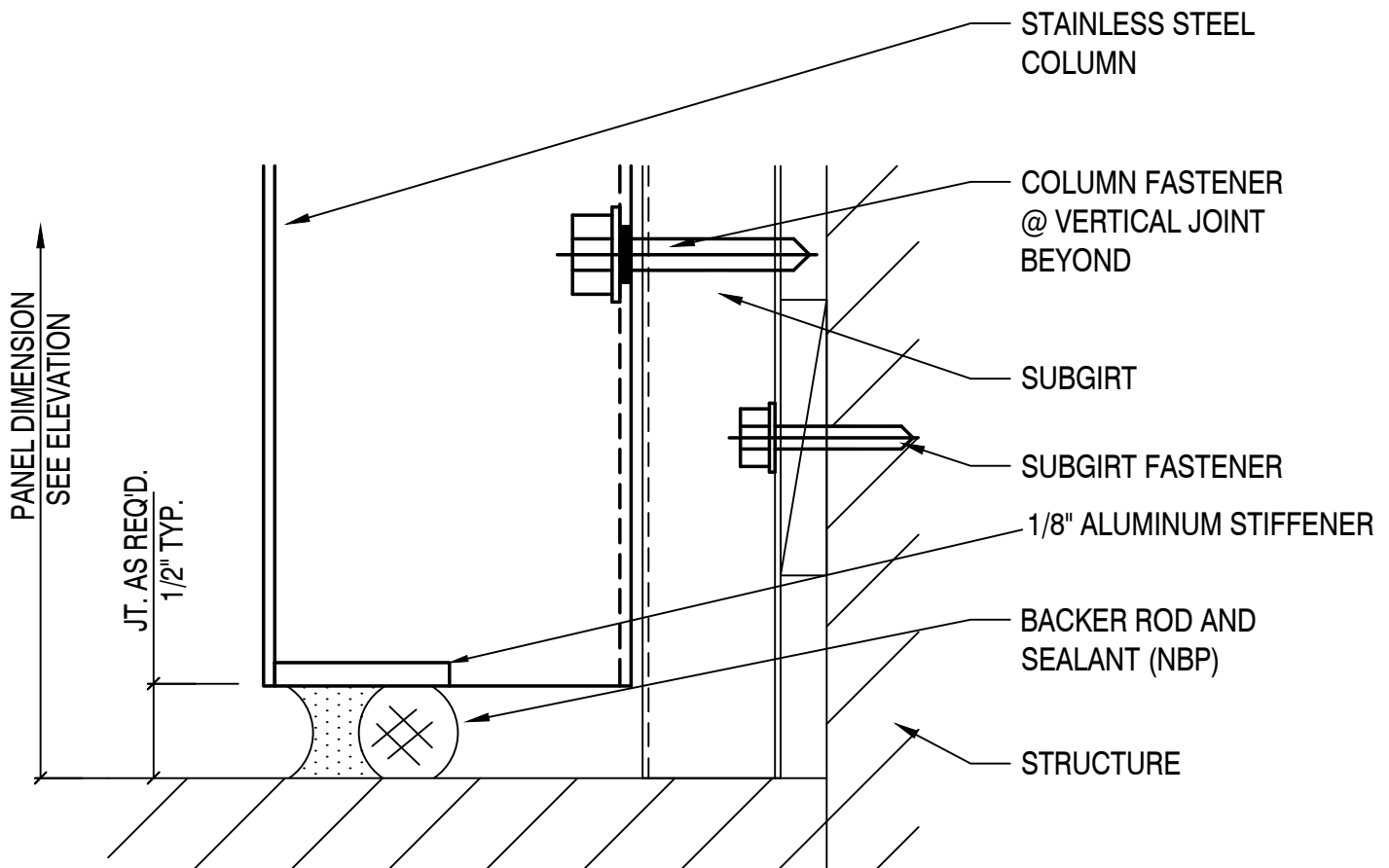

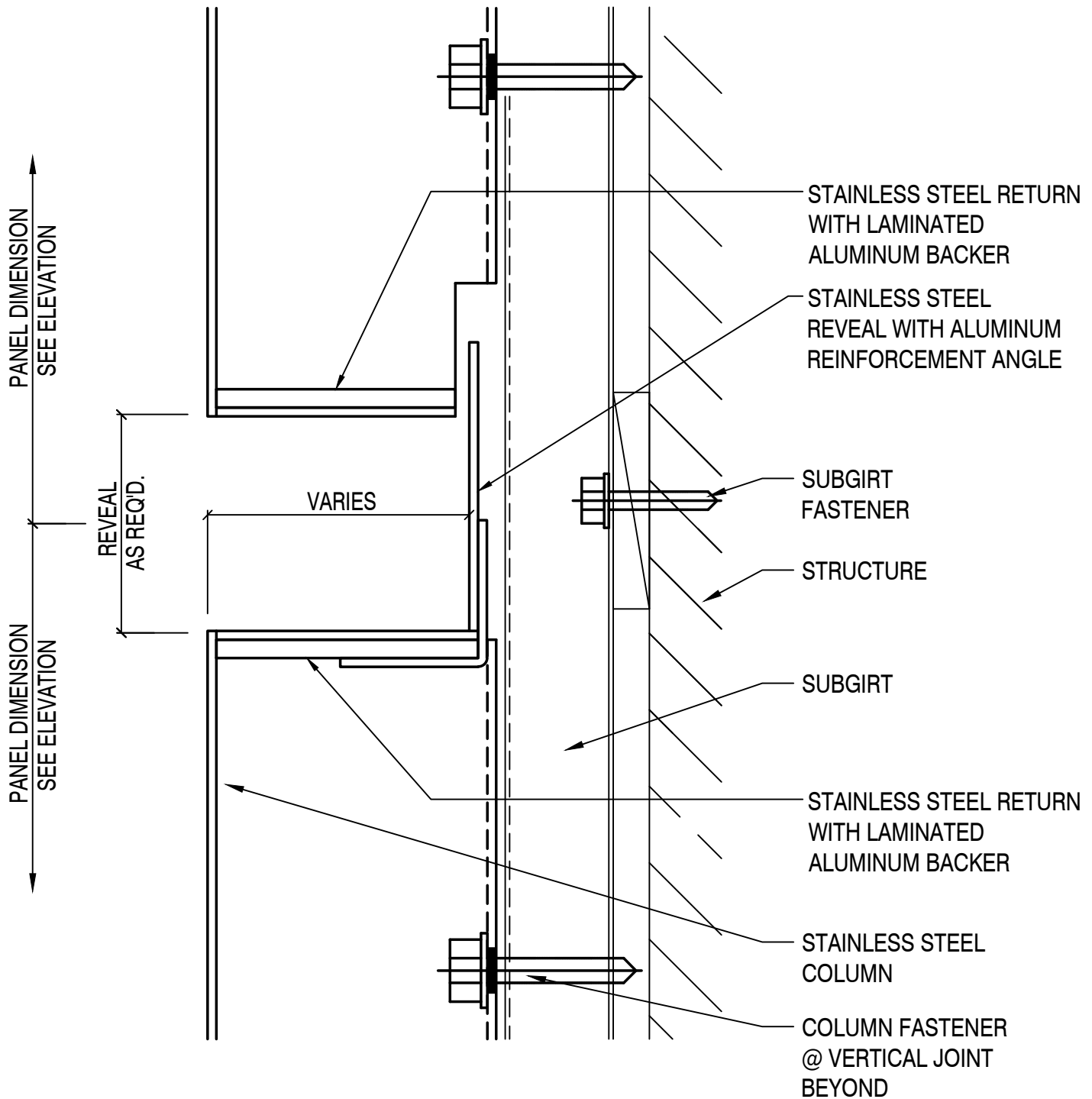



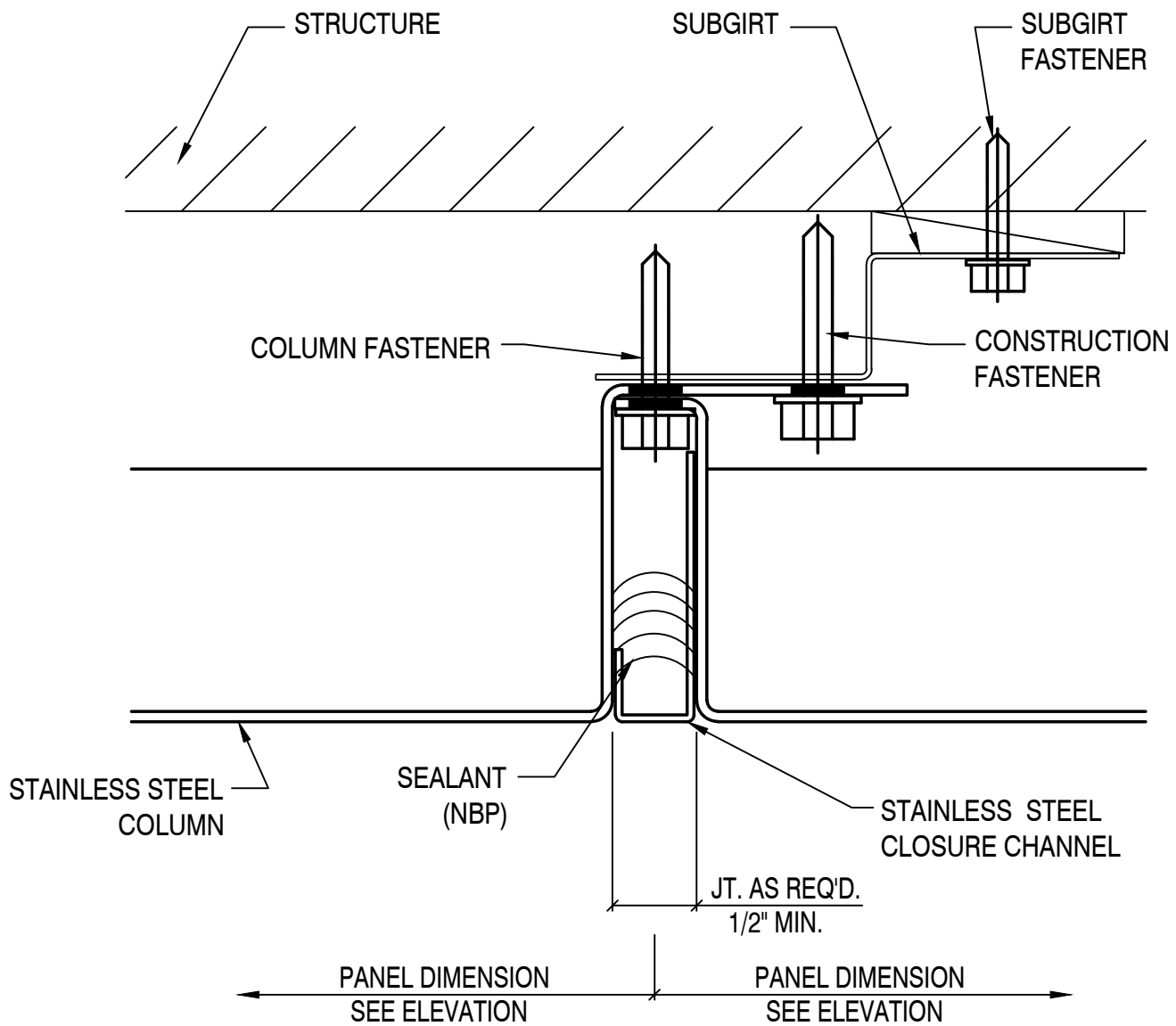

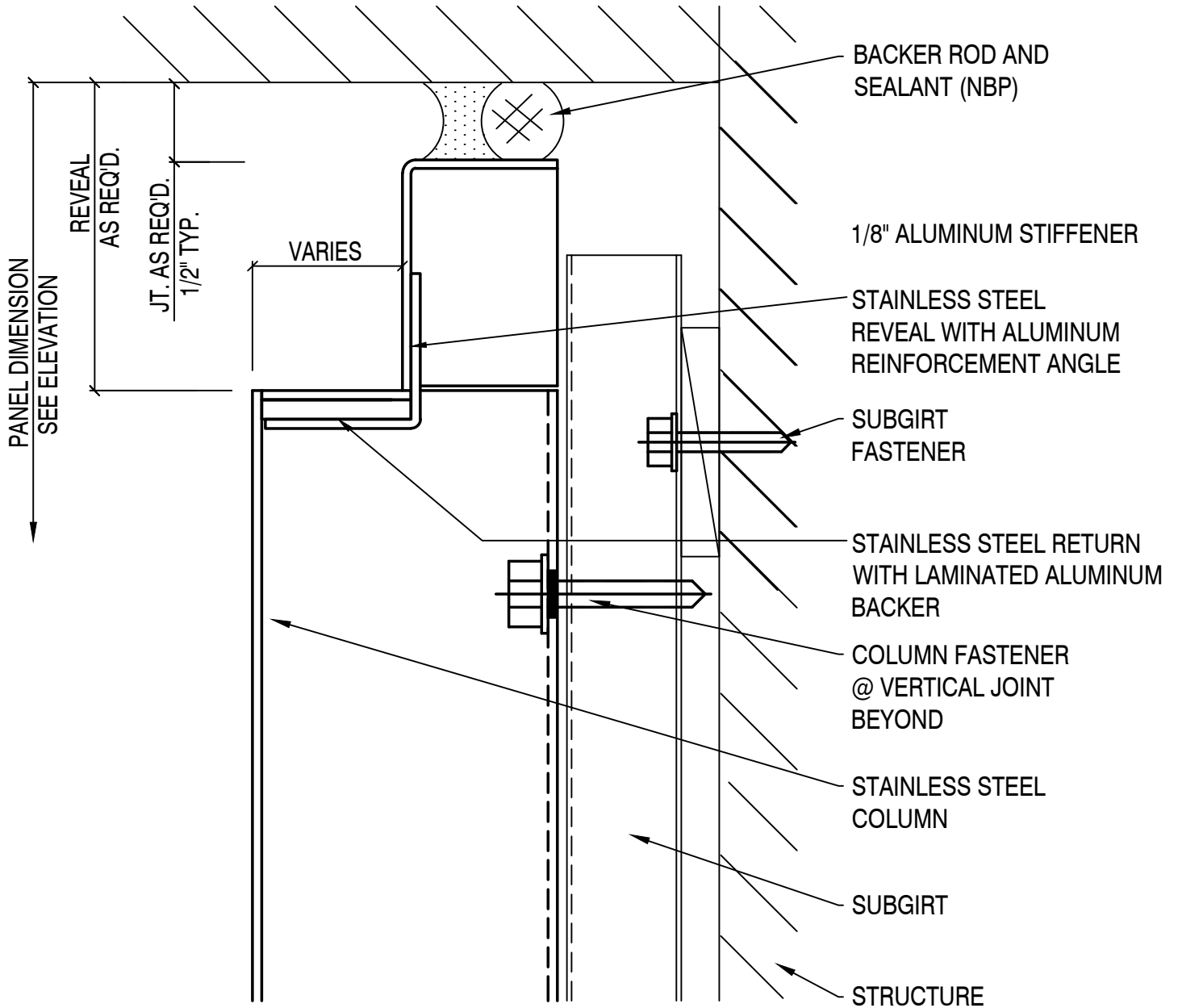

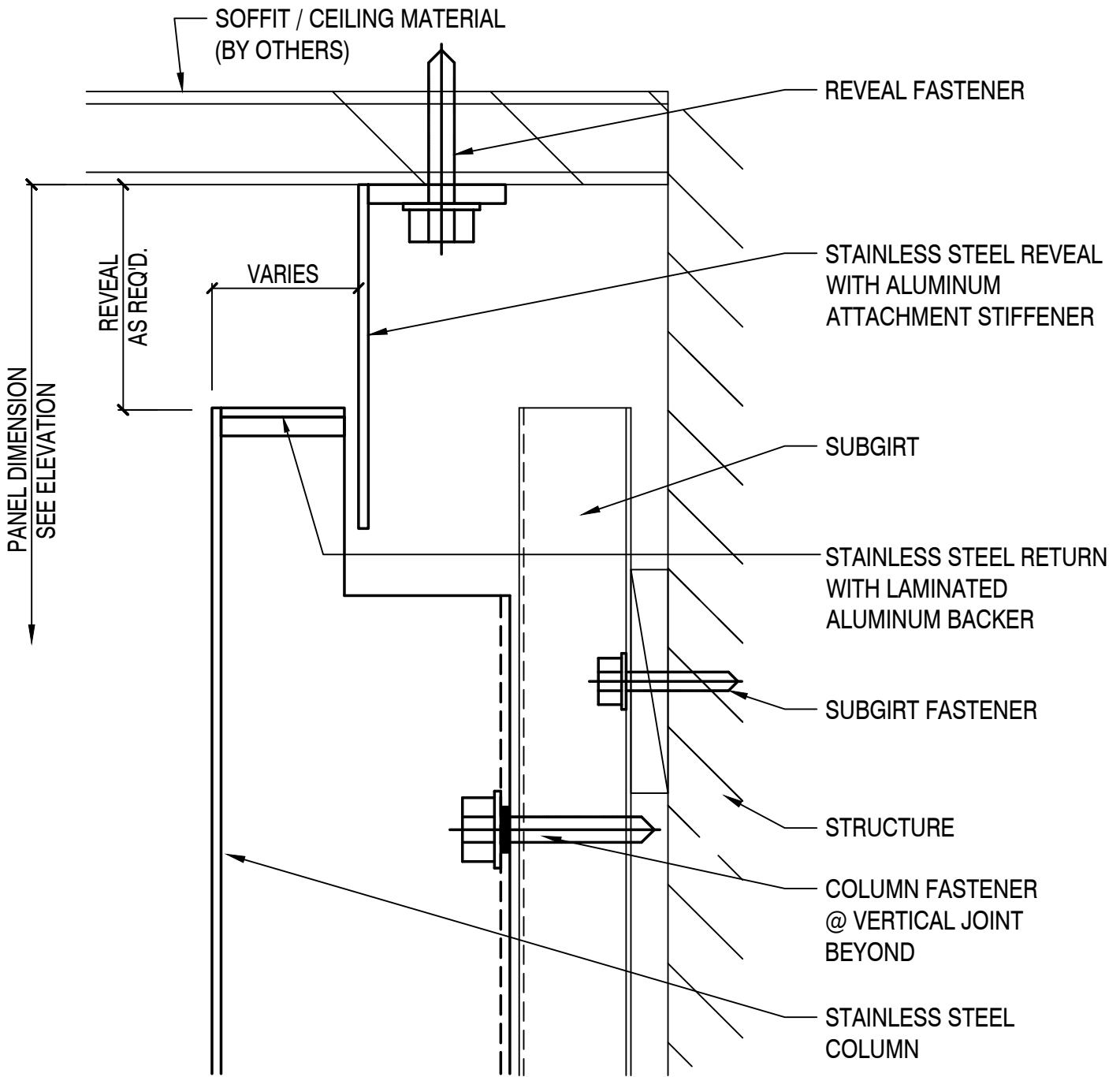

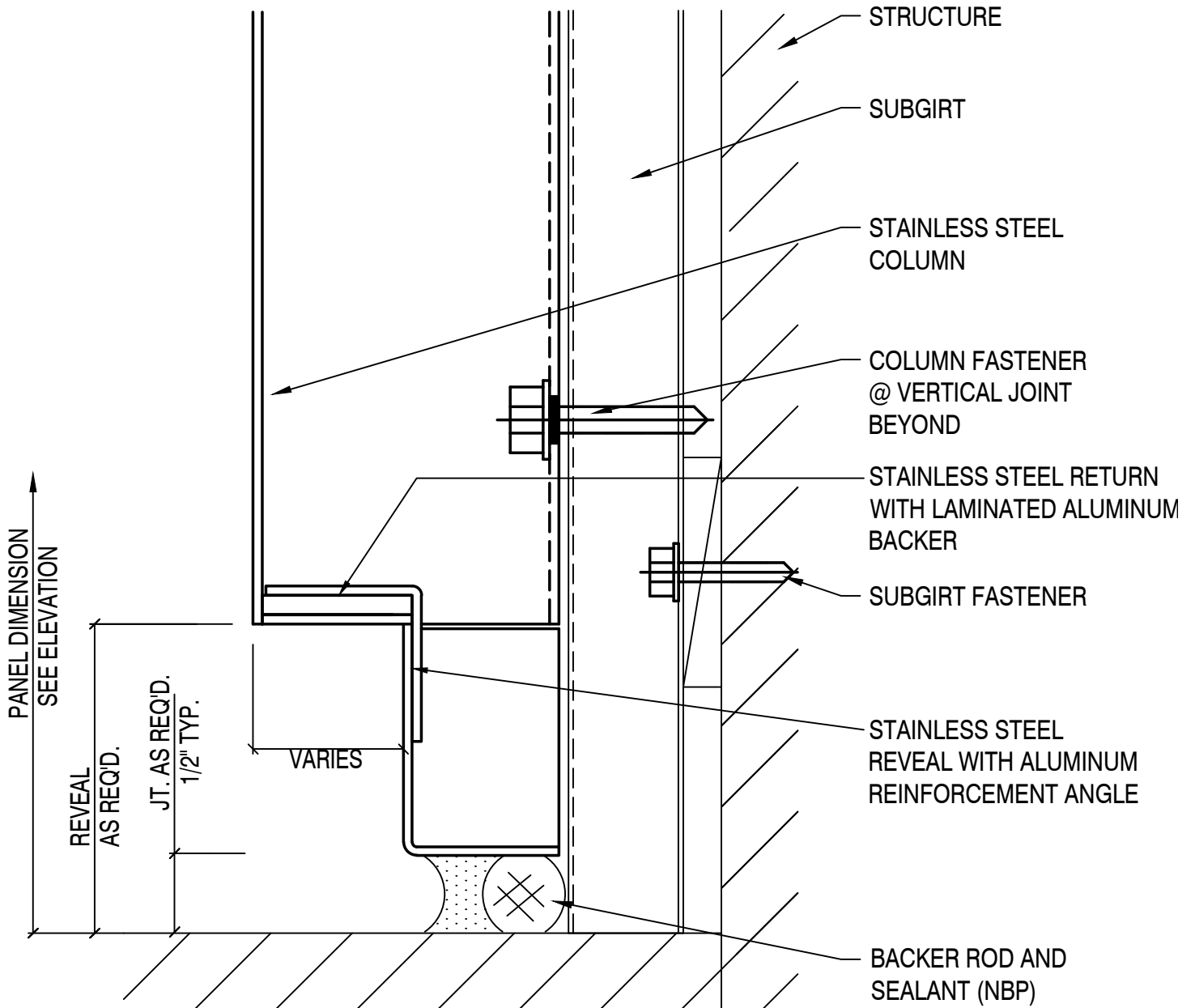

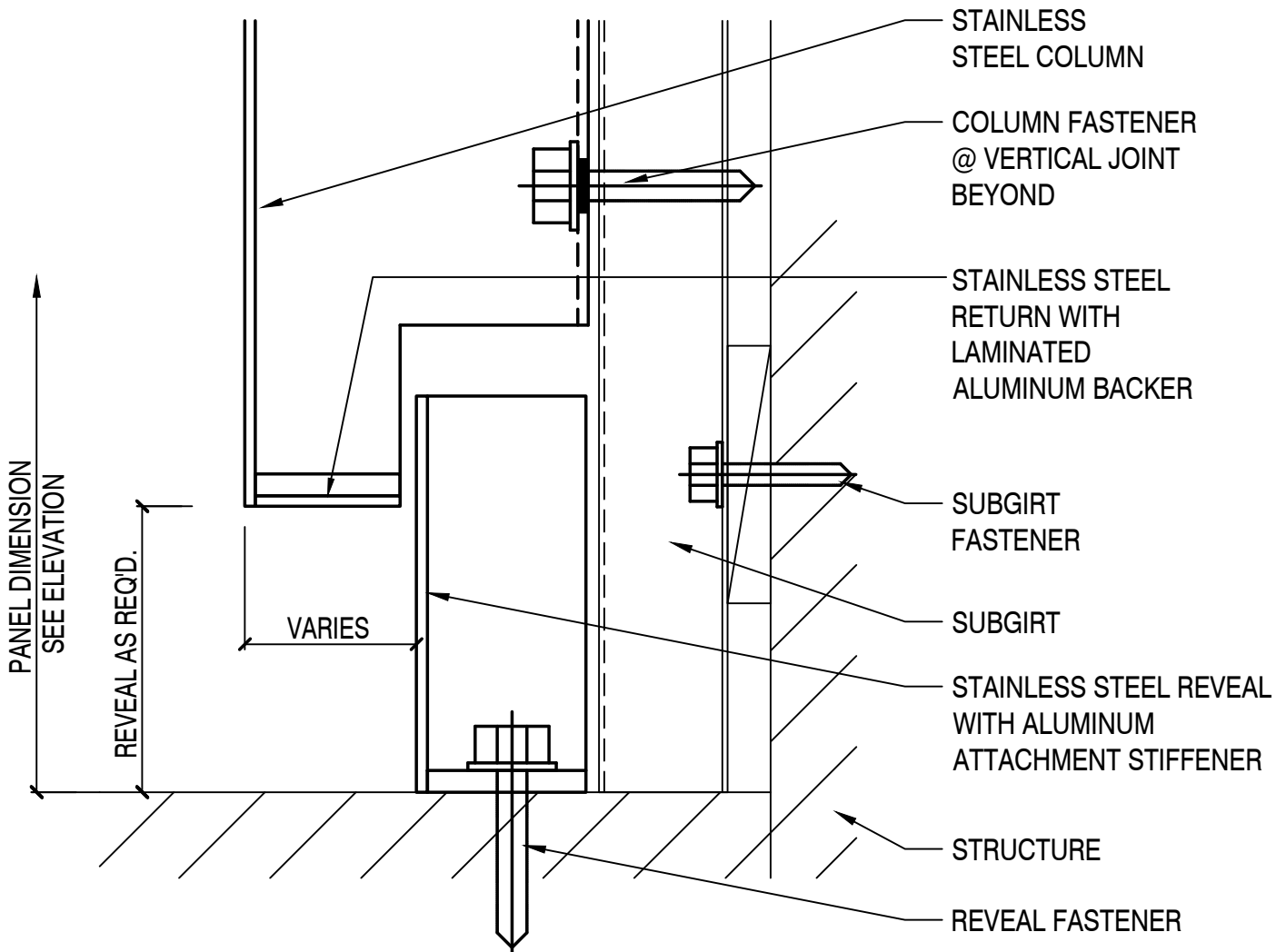

***Prōtean***

Construction Products, Inc.

SS-COL-300 Column Covers  
Standard Details

Typical Outside Corner

NOT USED

